

Operation manual

DWG-L Module ATEX Flow Monitor



meister®

Flow monitor for use
in explosion-hazard zones

Series DWG-L
Type DWG-L1,5 thru DWG-L100

Read this manual prior to performing any task!

Meister Strömungstechnik GmbH
Im Gewerbegebiet 2
63831 Wiesen
Germany
Telephone: +49 6096 9720 - 0
Fax: +49 6096 9720 - 30
E-mail: sales@meister-flow.com
Internet: www.meister-flow.com

DWG-L Modul ATEX, 3, en_US

These instructions were compiled by:
Meister Strömungstechnik GmbH
Subject to change without notice

© Meister Strömungstechnik GmbH 2021

These instructions facilitate the safe and efficient handling of a flow monitor (referred to as "device" in the following). The instructions are an integral part of the device and must be kept within easy reach for the personnel in the immediate vicinity of the device at all times. Personnel must carefully read and understand these instructions before commencing all work. The basic requirement for safe work is adherence to all safety and handling instructions stipulated in these instructions. The local accident-prevention regulations and general safety standards and regulations for the field of application of the device also apply. Illustrations in these instructions are provided to aid general understanding and might deviate from the actual model. No claims can be derived from any such differences.

Limitations of liability

All details and instructions in this manual have been compiled under consideration of the valid standards and regulations, the current state-of-technology and our many years of knowledge and experience. The manufacturer does not accept any liability arising from:

- non-observance of any details in these instructions
- improper use of the device, or use that is not in accordance with these instructions
- use of non-trained personnel

- unauthorized retrofitting or technical changes that have not been authorized by the manufacturer
- use of non-approved replacement parts

The duties and obligations agreed upon in the delivery contract apply in full, as well as the general terms and conditions, the terms of delivery by the manufacturer and the valid legal regulations applicable at the conclusion of the contract.

Copyright

These operating instructions are protected by copyright.

Except for internal purposes, transfer of these instructions to third-parties, copying them in any way – even in part – as well as dissemination and/or communication of their content is forbidden without prior written authorization from Meister Strömungstechnik ("manufacturer"). Violations are subject to claims for indemnification. The manufacturer reserves the right to assert additional claims.

Copyright is the property of the manufacturer.

© Meister Strömungstechnik GmbH

Im Gewerbegebiet 2
63831 Wiesen
Germany

Table of contents

| | | |
|----------|---|-----------|
| 1 | Overview | 6 |
| | 1.1 Short description..... | 6 |
| | 1.2 Warranty and guarantee provisions..... | 6 |
| | 1.3 Customer service..... | 6 |
| 2 | Safety | 7 |
| | 2.1 Explanation of symbols..... | 7 |
| | 2.2 Correct use in explosion-hazard zones..... | 8 |
| | 2.3 Special precautions for use in explosion-hazard zones..... | 10 |
| | 2.3.1 Precautions for use in explosion-hazard zones..... | 11 |
| | 2.4 Personnel requirements..... | 13 |
| | 2.5 Personal safety equipment..... | 13 |
| | 2.6 Protective systems..... | 13 |
| 3 | Areas of employment | 14 |
| | 3.1 Mechanical component (flow meter without limiting contacts and electrical components)..... | 14 |
| | 3.1.1 Exterior of the device..... | 14 |
| | 3.1.2 Interior of the device..... | 14 |
| | 3.1.3 General safety information for the mechanical component of the device..... | 15 |
| | 3.1.4 Categorization of the mechanical component of the flow monitor.. | 16 |
| | 3.1.5 List of media..... | 19 |
| | 3.1.6 Applicable documents..... | 21 |
| | 3.2 Electrical component of the device (limiting contacts)..... | 24 |
| | 3.2.1 Categorization of the electrical component of the flow monitor (limit switch contacts)..... | 24 |
| | 3.2.2 Applicable documents..... | 24 |
| 4 | Operating data | 34 |
| | 4.1 Operating data for the mechanical component of the device..... | 34 |
| | 4.2 Switch contact operating data..... | 34 |
| 5 | Transport, packaging and storage | 36 |

| | | |
|-----------|---|-----------|
| 6 | Installation and initial startup | 37 |
| 6.1 | Safety..... | 37 |
| 6.2 | Tools..... | 37 |
| 6.3 | Protection of the sight glass..... | 37 |
| 6.4 | Electrical connection..... | 37 |
| 6.5 | Grounding the device..... | 37 |
| 6.6 | Contact protection measures..... | 37 |
| 7 | Operation | 39 |
| 8 | Troubleshooting | 40 |
| 9 | Maintenance | 41 |
| 9.1 | Return Materials..... | 41 |
| 9.1.1 | Return Materials Authorization..... | 41 |
| 10 | Disassembly and disposal | 42 |
| 11 | Technical data | 43 |
| 11.1 | Dimension sheet..... | 43 |
| 11.2 | General specifications..... | 44 |
| 11.3 | Replacement parts..... | 46 |
| 12 | Annex | 48 |
| 13 | Index | 49 |

1 Overview

1.1 Short description



Fig. 1: DWG-L flow monitor

- 01 Explosion-proof switch contact with cast on power cable
- 02 Sight glass with measuring scale

The flow monitor DWG-L monitors the continuous flow of gaseous media. It is designed for installation into pipe systems.

A float inside the device is moved by the medium flowing through it. The current rate of flow can be read off on the measuring scale on the sight glass. The top edge of the float is the read off point.

Electrical monitoring is accomplished by explosion-proof limit switches. The electrical connection is via the cast on power cable.

1.2 Warranty and guarantee provisions

Warranty and guarantee provisions are contained in the general terms and conditions of the manufacturer.

1.3 Customer service

For technical information, please contact our customer service department (for contact details, see Page 2).

Furthermore, our staff is always interested in receiving new information and experiences gained from application of the device, which might be useful in improving our products.

2 Safety

This Chapter provides an overview of important safety aspects required for optimum protection of personnel as well as for safe installation and safe operation of the device.

Non-observance of the handling and safety instructions listed in this manual may result in hazardous/dangerous situations and in damage to property.

2.1 Explanation of symbols

Safety instructions

Safety instructions in this manual are marked by symbols. The safety instructions are preceded by signal words that indicate the level of danger/hazard.

To prevent accidents or injuries to persons as well as damage to property, always observe the safety instructions and proceed carefully.



DANGER!

This combination of symbol and signal word indicates an immediate, dangerous situation that results in death or serious injury if it is not avoided.



WARNING!

This combination of symbol and signal word indicates a possibly dangerous situation that might result in death or serious injuries if it is not avoided.

**CAUTION!**

This combination of symbol and signal word indicates a possibly dangerous situation that might result in minor or slight injuries if it is not avoided.

**NOTICE!**

This combination of symbol and signal word indicates a possibly dangerous situation that might result in damage to property and to the environment if it is not avoided.

Tips and recommendations

This symbol emphasizes useful tips and recommendations as well as information for efficient and failure-free operation.

Signs used in these instructions

The following symbols and highlighting are used in these instructions to identify handling instructions, the description of results, lists/enumerations, references and other elements:

- ➔ Designates step-by-step handling instructions.
- ⇒ Designates a state or an automatic sequence as a result of a specific operating step.
- Designates randomly ordered enumerations and list entries

🔗 *“Signs used in these instructions” on page 8*, designates references to chapters in these instructions.

2.2 Correct use in explosion-hazard zones

The device has been designed and constructed exclusively for the correct use in accordance with these instructions.

The flow monitor serves exclusively to monitor the continuous flow of gaseous media.

The areas of application are specified in Chapter 3 of these instructions.

The admissible operating conditions are specified in Chapter 4 of these instructions.

Correct use of the device includes the observance of all specifications in these Operating Instructions, as well as those for "DWG-L Module BASICS".

Any additional or different application, above and beyond the correct use in accordance with these instructions, is deemed as incorrect use.

 **WARNING!**

Danger due to incorrect use!

- Use the flow monitor only within the stipulated performance limits
- Do not subject the flow monitor to severe temperature fluctuations
- Do not use the flow monitor with quick-acting valves
- Do not use the flow monitor with solenoid valves
- Do not subject the flow monitor to vibrations
- Do not subject the flow monitor to pressure surges
- Do not use the flow monitor with media containing solids or abrasives
- Only use the flow monitor with media previously approved by the manufacturer
- Do not use the flow monitor as the sole monitoring device to prevent dangerous situations
- Do not install the flow monitor as a load bearing part within a pipeline system
- The flow monitor with sight glass must be installed in such a way as to preclude damage to the sight glass by outside force. If necessary, install an appropriate impact protection device

- The flow monitor may be installed in explosion-hazard zones only if:
 - the labeling on the flow monitor,
 - the labeling on the switch unit installed on the flow monitor,
 - and the information contained in the accompanying documentation (Operating instructions "DWG-L Module BASICS" and "DWG-L Module ATEX"), authorize such installation and operation
- Planning and design of equipment, protective systems and components is the responsibility of the facility operator
- The potential impact, in case of an explosion, must be taken into account by the facility operator
- The facility operator is responsible for the substitution, or the reduction of the quantity of substances, which may cause an explosive atmosphere.

All claims for damages due to incorrect use are excluded.

Incorrect use of the flow monitor may result in dangerous situations.

2.3 Special precautions for use in explosion-hazard zones

The following chapter lists residual risks that might arise from the device.

To reduce health risks and prevent dangerous situations, observe the safety instructions listed here, the safety instructions listed in other chapters of these operating instructions, as well as all safety instructions listed in the Operating Instructions for "DWG-L Module BASICS".



DANGER!

Danger due to the use of incorrect switch contacts

When an ATEX-certified device is delivered, the switching contact and device are permanently assigned to each other by serial numbers at the factory. The exchange of the switching contact is prohibited. In the event of a complaint, the entire device must be returned.



These Operating Instructions cannot cover all conceivable dangers because many dangers arise, not from the device itself, but from the respective media flowing through it. Always observe the appropriate safety data sheets when using hazardous media!

2.3.1 Precautions for use in explosion-hazard zones



DANGER!

Danger to life from explosions

- Potentially explosive dust-air mixtures and hybrid mixtures are not allowed inside the flow meter/flow monitor and must be excluded by the operator!
- Dust accumulations are not allowed inside the flow meter/flow monitor or on the outside surface and must be excluded by the operator! When cleaning, do not use dry cloths!
- To avoid electrostatic charges capable of resulting in dangerous situations, the following requirements must be met:
 - All conductive parts, capable of electrostatic charging, must be connected and grounded.
 - Dangerous electrostatic charging of non-conductive parts and materials, including solids, fluids and dust, must be avoided.
 - Ignitable discharges must be excluded.

- Chemical reactions, pyrolysis or biological processes inside the flow meter/flow monitor are not allowed and must be excluded by the operator.
- The entry of foreign materials that may produce sparks is not allowed and must be excluded by the operator.
- Friction, which may cause local heat build-up and sparking, is not allowed and must be excluded by the operator.
- Impact processes, involving materials such as rust or light alloys (e.g. aluminum or magnesium) are not allowed and must be excluded by the operator.
- High voltage and currents that may cause sparking are not allowed and must be excluded by the operator.
- Electromagnetic waves in a frequency range between 10^4 to 3×10^{12} Hz, as may be found in the vicinity of radio broadcasting stations or high-frequency generators, are not allowed and must be excluded by the operator.
- Electromagnetic waves in a frequency range between 3×10^{11} to 3×10^{15} Hz, which can occur as radiation from protective systems or components (e.g. lamps, arc lamps, lasers), are not allowed and must be excluded by the operator.
- Devices which can focus radiation, and which can provide an ignition source for particles and surfaces, are not allowed and must be excluded by the operator.
- Ionizing radiation that exceeds the minimum ignition temperature of the surrounding explosive atmosphere, is not allowed and must be excluded by the operator.
- Ultrasound sources, which can ignite the sonicated material, are not allowed and must be excluded by the operator.
- Adiabatic compression and shock waves are not allowed and must be excluded by the operator.
- Exothermic reactions, including auto-ignition of dust, is not allowed and must be excluded by the operator.

2.4 Personnel requirements

WARNING!

Risk of injury due to insufficiently trained and qualified personnel!

If unqualified personnel work on the device or are located within its hazard zone, dangers arise which may result in serious injuries and considerable damage to property.

- All work must be performed by qualified personnel only
- Keep unqualified personnel away from hazard zones

The personnel requirements, as formulated in the Operating Instructions for "DWG-L Module BASICS" Chapter 2.4, are valid. For employment within explosion-hazard zones, only trained and qualified personnel may be used. Responsibility for the choice of personnel and their qualification rests with the facility operator. The requirements for standards DIN EN 60079-14 and DIN EN 60079-17 must be taken into consideration.

Refer also to the Operating Instructions "DWG-L Module BASICS", Chapter 2.9 "Responsibility of the owner".

Authorized personnel is to be restricted to those persons who can be expected to carry out their work reliably. Persons whose ability to respond is influenced, e.g. by drugs, alcohol or medication, are not authorized.

Observe the age and occupational regulations at the site when choosing personnel.

2.5 Personal safety equipment

Personal safety equipment is used to protect personnel from hazards/dangers that might impair their safety or health during work.

When performing the various tasks at, and with the device, personnel must wear personal safety equipment. Special reference to this equipment is made in the Operating Instructions for "DWG-L Module BASICS". The facility operator must ensure that the protective clothing used in explosion-hazard zone is suitable and approved.

2.6 Protective systems

The design of the safety features is described in the Operating Instructions "DWG-L Module BASICS". The operator must ensure that all applicable regulations which apply to operation in explosion-hazard zone are met.

3 Areas of employment

3.1 Mechanical component (flow meter without limiting contacts and electrical components)

3.1.1 Exterior of the device

- Devices of the DWG-L type may be employed in areas in which an explosive atmosphere, composed of a gas/air- or dust/air- mixture, may occasionally occur. The exterior of the device may therefore be suitably located in explosion hazard zone 1, zone 2, zone 21, or zone 22
- Dust accumulations are not permitted; neither internally, nor on the outside surface of the flow meter/flow monitor and must be excluded by the operator.

3.1.2 Interior of the device

- Inside the device, only those flow media may be used, to which the following applies:
 - the medium is listed on the media list (Chapter 3.1.5), and
 - the medium is not aggressive to the wetted parts of the device, and
 - the device is approved by the manufacturer for use with the medium
- It is permissible to occasionally have an explosive gas/air mixture inside the device (explosion hazard zone 1). At no time may gasses of explosion hazard group IIC (e.g. hydrogen or acetylene) be present inside the device.
- Explosive dust-air mixtures and hybrid mixtures are not permitted inside the flow meter(flow monitor and must be excluded by the operator.
- Chemical reactions, pyrolysis or biological processes inside the flow meter/flow monitor are not permitted and must be excluded by the operator.
- The entry of foreign materials which may produce sparks is not permitted and must be excluded by the operator.

3.1.3 General safety information for the mechanical component of the device

- Dust accumulations are not permitted; neither internally, nor on the outside surface of the flow meter/flow monitor and must be excluded by the operator. When cleaning, do not use dry cloths!
- In case of hazard through static electricity, the following requirements must be met:
 - All conductive parts capable of charging themselves electrostatically must be connected and grounded
 - Dangerous electrostatic charging of non-conductive parts and materials, including solids, fluids and dust, must be avoided
 - Ignitable discharges must be excluded
- Friction, which may cause local heat build-up and sparking, is not allowed and must be excluded by the operator
- Impact processes involving materials such as rust or light alloys (e.g. aluminum or magnesium) are not allowed and must be excluded by the operator
- High voltage and currents that may cause sparking are not allowed and must be excluded by the operator
- Electromagnetic waves in a frequency range between 10^4 to 3×10^{12} Hz, as may be found in the vicinity of radio broadcasting stations or high-frequency generators, are not allowed and must be excluded by the operator
- Electromagnetic waves in a frequency range between 3×10^{11} to 3×10^{15} Hz, which can occur as radiation from protective systems or components (e.g. lamps, arc lamps, lasers), are not allowed and must be excluded by the operator
- Devices which can focus radiation, and which can provide an ignition source for particles and surfaces, are not permitted and must be excluded by the operator
- Ionizing radiation that exceeds the minimum ignition temperature of the surrounding explosive atmosphere, is not allowed and must be excluded by the operator
- Ultrasound sources, which can ignite the sonicated material, are not allowed and must be excluded by the operator
- Adiabatic compression and shock waves are not allowed and must be excluded by the operator

- Exothermic reactions, including auto-ignition of dust, is not allowed and must be excluded by the operator
- The flow monitor must be installed in such a way as to preclude damage by outside force. This is especially so for devices with sight glass. It must be ensured that the sight glass cannot be damaged. If necessary, install an appropriate impact protection shield.

3.1.4 Categorization of the mechanical component of the flow monitor

- Equipment group
internal: II
external: II
- Equipment category
internal: 2
external: 2
- Atmosphere
internal: Gas (G)
external: Gas (G), Dust (D)
- Type of protection: h (Constructional Safety "c")
- Gas group
internal: IIB
external: IIC, IIIC
- Temperature classification
internal: T6
external: T6
external: T80 °C
Operating temperatures for device without limit switch contacts
The maximum media temperature for a device without limit switch contacts must be less than:
 - the ignition temperature of the medium and
 - the ignition temperature of the atmosphere surrounding the device and
 - less than or equal to 80 °C

It is the responsibility of the operator to ensure that these requirements are met concurrently.

The **minimum media temperature for a device without limit switch contacts** must be higher than or equal to - 20 °C.

It must be ensured that the medium does not freeze.

The **maximum ambient temperature for a device without limit switch contacts** must be less than:

- the ignition temperature of the medium and
- the ignition temperature of the atmosphere surrounding the device and
- less than or equal to 80 °C

It is the responsibility of the operator to ensure that these requirements are met concurrently.

The **minimum ambient temperature for a device without limit switch contacts** must be higher than or equal to - 20 °C.

Operating temperatures for a device with the following limit switch contacts:

Explosion proof switch contacts with design examination:

PTB 03 ATEX 2154 X

 II 2 G Ex mb IIC T6 Gb

 II 2 D Ex tb IIIC T80 °C Db

The **maximum media temperature for a device with these limit switch contacts** must be less than:

- the ignition temperature of the medium and

- the ignition temperature of the atmosphere surrounding the device and
- less than or equal to 75 °C

It is the responsibility of the operator to ensure that these requirements are met concurrently

The **minimum media temperature for a device with these limit switch contacts** must be higher than or equal to - 20 °C .

It must be ensured that the medium does not freeze

The **maximum ambient temperature for a device with these limit switch contacts** must be less than:

- the ignition temperature of the medium and
- the ignition temperature of the atmosphere surrounding the device and
- less than or equal to 75 °C

It is the responsibility of the operator to ensure that these requirements are met concurrently.

The **minimum ambient temperature for a device with these limit switch contacts** must be higher than or equal to - 20 °C.

Operating temperatures for a device with the following limit switch contacts:

Explosion proof switch contacts with design examination:

PTB 03 ATEX 2154 X

 II 2 G Ex mb IIC T5 Gb

 II 2 D Ex tb IIIC T100 °C Db

Mechanical component (flow meter without limiting contacts and electrical components) > Categorization of the mechanical component of the flow monitor

The **maximum media temperature for a device with these limit switch contacts** must be less than:

- the ignition temperature of the medium and
- the ignition temperature of the atmosphere surrounding the device and
- less than or equal to 80 °C

It is the responsibility of the operator to ensure that these requirements are met concurrently

The **minimum media temperature for a device with these limit switch contacts** must be higher than or equal to - 20 °C.

It must be ensured that the medium does not freeze.



The **maximum ambient temperature for a device with these limit switch contacts** must be less than:

- the ignition temperature of the medium and
- the ignition temperature of the atmosphere surrounding the device and
- less than or equal to 80 °C

It is the responsibility of the operator to ensure that these requirements are met concurrently

The **minimum ambient temperature for a device with these limit switch contacts** must be higher than or equal to - 20 °C.

- EPL (Equipment Protection Level):
Gb (Gas), Db (Dust)

- Labeling of the mechanical component of the flow meter/monitor:
Internal:  II 2G Ex h IIB T6 Gb
External:  II 2G Ex h IIC T6 Gb
External:  II 2D Ex h IIIC T80 °C Db

3.1.5 List of media

| Media used | | Ignition temp. | Explosion limit [%] | |
|---|---|-------------------|---------------------|-------|
| | | | Lower | Upper |
| Argon | | Inert gas | | |
| Cargon | Gaseous mixture Argon+ CO ₂ | | | |
| CO ₂ | | Inert gas | | |
| CO ₂ liquid | | | | |
| Diesel | | 255 (ASTME659-78) | 0,6 | 6,5 |
| Biodiesel SME | Soya seed oil methyl ester | 285 (ASTME659-78) | | |
| Biodiesel RME | Rape seed oil methyl ester | 283 (ASTME659-78) | | |
| EDC | (1,2-Dichlorethane) | 440 | 6,2 | 16 |
| Natural gas | | 575 - 640 | 4 | 17 |
| Ethanol | | 400 | 3,1 | |
| City gas | | 560 | | |
| Gaseous mixture 90 % Argon + 10 % CO ₂ | | | | |
| Gaseous mixture 96 % Argon + 4 % O ₂ | | | | |
| Helium | | none | none | none |
| Air | | | | |
| Methane | | 595 | 4,4 | 16,5 |

| Media used | | Ignition temp. | Explosion limit [%] | |
|---|---|----------------|---------------------|-------|
| | | | Lower | Upper |
| Methanol | | 455 | 6,1 | 44 |
| N ₂ | | none | none | none |
| N ₂ O | | none | none | none |
| NaOH | Natrium-hydroxide-NaOH ("caustic soda") | none | none | none |
| NaOH 50% | | none | none | none |
| Caustic soda NaOH 25% | | none | none | none |
| NH ₃ | Anhydrous ammonia | 630 | 15 | 28 |
| n-Heptan (highly purified) | | 215 | 1 | 6,7 |
| O ₂ | | none | none | none |
| Oil | | | | |
| organic Salt solution density 1,35 kg/l 20 °C | | | | |
| Peroxide | | none | none | none |
| RAF2 | Raffinate 2 | 385 | 1,6 | 10 |
| Spirits of Ammonia (25%) | | 630 | 15 | 28 |
| SO ₂ | Sulphur dioxide | none | none | none |

| Media used | | Ignition temp. | Explosion limit [%] | |
|--|--|----------------|---------------------|-------|
| | | | Lower | Upper |
| Solvana 2000 (Universal cleaning agent) | | 236 | 0,4 | 7 |
| Petroleum ether | | >200 | 0,6 | 7 |
| Water | | none | none | none |
| Water / Nitrite-solution | | | | |
| Hydrogenperoxyde 50% (ultra pure) | | none | none | none |
| Hydrogenperoxyde 50 weight.-%, dissolved in Water | | none | none | none |
| Propane | | 470 | 2,2 | 9,5 |
| n-Butane | | 365 | 1,4 | 8,5 |

3.1.6 Applicable documents

Meister Strömungstechnik GmbH
Im Gewerbegebiet 2
63831 Wiesen
Germany

EU-Declaration of Conformity

in accordance with EU-Directive 2014/34/EU
on equipment and protective systems intended for use
in potentially explosive atmospheres

We declare under sole responsibility, that the products listed below are in compliance with the requirements of EU-Directive 2014/34/EU and that these products are not stand alone devices, but are intended for installation as a part of a machine or system, whereby operation is prohibited until such time as it is ensured that the machine or system, in its entirety, is in compliance with the EU-Directives.

Float-type Flowmeter, Series DWG-L

The flowmeter is used for measuring and monitoring the continuous volume flow of gases and is suitable for use with explosion-proof limit contacts with the designation SEM-A and / or SEM-E (Type –examination PTB 03 ATEX 2154 X).
A separate Declaration of Conformity exists for these contacts.

The float-type Flowmeters of the DWG-L series comply with the requirements of EU-Directive 2014/34/EU and are categorized as follows:



Interior of the Flowmeter:

Equipment-group II, category 2 G, for gases of gas group IIB, temperature classification T6

Marking: Interior  II 2G Ex h IIB T6 Gb

Exterior of the Flowmeter:

Equipment-group II, category 2 G or 2 D, for gases of gas group IIC or combustible dust IIIC, temperature classification T6 or T80°C

Marking: Exterior  II 2G Ex h IIC T6 Gb
 II 2D Ex h IIIC T80°C Db

During the conformity appraisal procedures, it was found that no effectual ignition source is existent, if the device is employed and operated as intended and in compliance with all requirements of the operating instructions for DWG-L module BASICS and DWG-L module ATEX. Meister Strömungstechnik GmbH therefore affixes the Ex-marking under its own responsibility.

Conformity of the described product with Directive 2014/34/EU is proven through full compliance with the following standards:

Harmonized European standards:

DIN EN ISO 80079-36:2016

Explosive atmospheres - Part 36: Non-electrical equipment for explosive atmospheres - Basic method and requirements

DIN EN ISO 80079-37:2016

Explosive atmospheres - Part 37: Non-electrical equipment for explosive atmospheres - Non-electrical type of protection constructional safety "c", control of ignition sources "b", liquid immersion "k"

EN 1127-1:2019

Explosive atmospheres - Explosion prevention and protection - Part 1: Basics concepts and methodology

Copies of the technical documentation for the conformity appraisal procedure are deposited at:

Bureau Veritas Consumer Products Services Germany GmbH

Businesspark A96, 86842 Türkheim, Germany

Identification number of notified body: 2004

Accession number: 11TH0271

Place and date/

Name and signature of authorized person

Wiesen, April 24, 2020



MASTERPIECES
MADE IN GERMANY

Simon Mill
Managing Director

3.2 Electrical component of the device (limiting contacts)

The electrical limiting contacts were subjected to design examination: PTB 03 ATEX 2154 X

The electrical limiting contacts may only be employed in combination with DWG-L type devices, in areas in which an explosive atmosphere, composed of a gas/air- or dust/air- mixture, may occasionally occur. The limiting contacts of the device may therefore be suitably located in explosion hazard zone 1, zone 2, zone 21, or zone 22. Dust accumulations are not permitted on the limiting contacts and must be excluded by the operator.

3.2.1 Categorization of the electrical component of the flow monitor (limit switch contacts)

- Device group: II
- Device category: 2
- Atmosphere: Gas (G), Dust (D)
- Gas group: IIC, Dust group: IIIC
- Ignition protection class (Gas): mb (Encapsulation, application in zone 1 and 2)
- Ignition protection category (Dust): tb (protection by enclosure, application in zone 21 and 22)
- Temperature class (Gas): T5, T6

- Maximum permissible surface temperature (Dust): T 80 °C, T 100 °C
- EPL (Equipment Protection Level): Gb (Gas), Db (Dust)

3.2.2 Applicable documents

The electrical limiting contacts were subjected to a design examination

PTB 03 ATEX 2154 X

The following documents must be observed:

Manufacturer's declaration for the employment of explosion-proof switch units within a safety concept

- Design examination certificate with attachments
- Conformity declaration (Meister Strömungstechnik GmbH)
- Operating Instructions for the switch units

MANUFACTURER'S DECLARATION

to the application of switch units,
Type SEM-E and SEM-A with
EC-Type Examination Certificate PTB 03 ATEX 2154 X

The switch unit may only be used in conjunction with flow meters, which have previously been approved by us (hereinafter referred to as „Device Unit“)

The safety concept and its implementation by the operator of the plant, in which the device unit is used, must have mandatory, multiple levels of redundancy. The device unit is not certified for employment as exclusive safety component in the event of a breakdown, disruption or malfunction, which may cause damage or injury to persons, animals or property.

Therefore, the operator is solely liable; the liability of the manufacturer is, to the extent legally permitted, excluded.

Wiesen, 22 November 2018

Legally binding signature of the authorized person



Rosemarie Mill



(1) **EU-TYPE EXAMINATION CERTIFICATE**
(Translation)

(2) Equipment or Protective Systems Intended for Use in
Potentially Explosive Atmospheres - **Directive 2014/34/EU**

(3) EU-Type Examination Certificate Number:

PTB 03 ATEX 2154 X

Issue: 01

(4) Product: Switchgear unit, type SEM-E and SEM-A

(5) Manufacturer: Meister Strömungstechnik GmbH

(6) Address: Im Gewerbegebiet 2, 63831 Wiesen, Germany

(7) This product and any acceptable variation thereto is specified in the schedule to this certificate and the documents therein referred to.

(8) The Physikalisch-Technische Bundesanstalt, notified body No. 0102 in accordance with Article 17 of the Directive 2014/34/EU of the European Parliament and of the Council, dated 26 February 2014, certifies that this product has been found to comply with the Essential Health and Safety Requirements relating to the design and construction of products intended for use in potentially explosive atmospheres, given in Annex II to the Directive.

The examination and test results are recorded in the confidential Test Report PTB Ex 18-25131.

(9) Compliance with the Essential Health and Safety Requirements has been assured by compliance with:
EN 60079-0:2018, EN 60079-18:2015 + A1:2017, EN 60079-31:2014

(10) If the sign "X" is placed after the certificate number, it indicates that the product is subject to the Specific Conditions of Use specified in the schedule to this certificate.

(11) This EU-Type Examination Certificate relates only to the design and construction of the specified product in accordance to the Directive 2014/34/EU. Further requirements of the Directive apply to the manufacturing process and supply of this product. These are not covered by this certificate.

(12) The marking of the product shall include the following:

 **II 2 G Ex mb IIC T5, T6 Gb and II 2 D Ex tb IIIC T80 °C, T100 °C Db**

Konformitätsbewertungsstelle - Sektor Explosionsschutz

Braunschweig, October 29, 2018

On behalf of PTB:

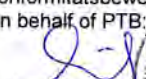
Dr.-Ing. F. Lienesch
Direktor und Professor



SCHEDULE

(13)

(14) **EU-Type Examination Certificate Number PTB 03 ATEX 2154 X, Issue: 01**

(15) Description of Product

The SEM-* switchgear unit is an encapsulated reed contact, which is used as a limit switch. Type SEM-E is a two-pole normally-open contact. Type SEM-A is a three-pole changeover contact.

Electrical data

| Type | | SEM-E | SEM-A |
|---------------|-----------|----------------|------------|
| Contact | | normally close | changeover |
| Rated voltage | U_{max} | 250 V | 250 V |
| Rated Current | I_{max} | 2 A | 1 A |
| Maximum power | P_{max} | 60 W | 30 W |

The marking depends on the ambient temperature range as follows

| | | |
|----------------------|---|------------------------------|
| -20 °C ≤ Ta ≤ +75 °C |  | II 2 G Ex mb IIC T6 Gb |
| |  | II 2 D Ex tb IIIC T80 °C Db |
| -20 °C ≤ Ta ≤ +90 °C |  | II 2 G Ex mb IIC T5 Gb |
| |  | II 2 D Ex tb IIIC T100 °C Db |

Changes with respect to previous editions

Verification of compliance with the specified state of standards.

(16) Test Report PTB Ex 18-25131

SCHEDULE TO EU-TYPE EXAMINATION CERTIFICATE PTB 03 ATEX 2154 X, Issue: 01

(17) Specific conditions of use

1. A fuse according to IEC 60127-2-1 corresponding to rated current or a motor protection switch with instantaneous short-circuit or thermal release shall be connected in series to each switchgear unit. The Fuse may be accommodated in the associated supply unit or shall be connected in series. The rated voltage of the fuse shall be higher than or equal to the maximum value of the rated voltage of the switchgear unit. The breaking capacity of the fuse shall be higher than or equal to the prospective maximum short circuit current at the place of installation (usually 1500 A).
2. The switchgear units are intended to be used in mounting rails only.
3. The connected circuit shall not include any effective inductances or capacitances.
4. The switchgear unit may also be connected to an intrinsically safe circuit. In this case the protective fuse may be dispensed with.
5. Inside of hazardous areas the connecting cable shall be connected in an enclosure that complies with the requirements of an acknowledged type of protection according to EN 60079-0.

(18) Essential health and safety requirements

Met by compliance with the aforementioned standards.

According to Article 41 of Directive 2014/34/EU, EC-type examination certificates which have been issued according to Directive 94/9/EC prior to the date of coming into force of Directive 2014/34/EU (April 20, 2016) may be considered as if they were issued already in compliance with Directive 2014/34/EU. By permission of the European Commission supplements to such EC-type examination certificates and new issues of such certificates may continue to hold the original certificate number issued before April 20, 2016.

Konformitätsbewertungsstelle, Sektor Explosionsschutz

Braunschweig, October 29, 2018

On behalf of PTB:

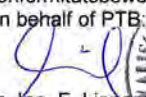
Dr.-Ing. F. Lienesch
Direktor und Professor



OPERATING INSTRUCTIONS

Explosion-proof contacts according to ATEX 2154 X

- **Technical Safety Data Model**
SEM-A (SPDT/Change Over) + SEM-E (SPST/Normally Open)

Manufacturer: Meister Strömungstechnik GmbH / Im Gewerbegebiet 2 / D-63831 Wiesen

| EN 60079-0: 2018 / EN 60079-18:2015 / EN 60079-18/A1:2018 / EN 60079-31:2014 | |
|--|---|
| T6 | T5 |
| Typ SEM – A... CE 0102 max. ambient temperature 75 °C | Typ SEM – A... CE 0102 max. ambient temperature 90 °C |
| ⊕II 2G Ex mb IIC T6 Gb + ⊕II 2D Ex tb IIIC T80 Db | ⊕II 2G Ex mb IIC T5 Gb + ⊕II 2D Ex tb IIIC T100 Db |
| Typ SEM – E... CE 0102 max. ambient temperature 75 °C | Typ SEM – E... CE 0102 max. ambient temperature 90 °C |
| ⊕II 2G Ex mb IIC T6 Gb + ⊕II 2D Ex tb IIIC T80 Db | ⊕II 2G Ex mb IIC T5 Gb + ⊕II 2D Ex tb IIIC T100 Db |

Approval: EX-Type Examination Certificate PTB 03 ATEX 2154 X

- **Startup**

The switch unit may only be connected to circuits with the following maximum ratings:

SEM-A: U_{max} : 250 V / I_{max} : 1 A / P_{max} : 30 W

SEM-E: U_{max} : 250 V / I_{max} : 2 A / P_{max} : 60 W

The circuit must not incorporate any effective inductivities or effective capacities. Above mentioned max. ratings must never be exceeded. For contact protection a fuse with the nominal value

of 1 A for SEM-A respectively 2 A for SEM-E

must be provided outside of the hazardous area for the circuit, unless the switch unit is connected to an intrinsically safe circuit.

- **Application**

The switch unit may be used in potentially explosive atmospheres classified as Category 2.

- **Mounting**

The switch unit must be inserted between the mounting rails and then tightened with 2 screws.

▪ **Maintenance**

There is no maintenance required. Repairs are not permitted!

▪ **Installation**

The electrical connections must be made in accordance to local safety regulations for electrical equipment and under observance of the regulations for the installation of electrical equipment in hazardous areas. The connection circuits must be designed with increased safety, if the device is not connected to intrinsically safe circuits.

▪ **Adjustment**

Except for the switch point, no other adjustments have to be made.

▪ **Relevant safety data**

The following limit must not, under any circumstances, be exceeded, even for a very short time.
The following limit values must never be exceeded, even for short periods.

| Type | SEM-A (T5) | SEM-E (T5) | SEM-A (T6) | SEM-E (T6) |
|---------------------------------|------------|------------|------------|------------|
| Operating voltage | max. 250 V | max. 250 V | max. 250 V | max. 250 V |
| Switch current | max. 1 A | max. 2 A | max. 1 A | max. 2 A |
| Contact Rating | max. 30 W | max. 60 W | max. 30 W | max. 60 W |
| Max. ambient temperature | 90 °C | 90 °C | 75 °C | 75 °C |

The unit must not be used in areas where electrostatic charging of the plastic housing might occur.

▪ **Warning**

Do not clean the switch unit with aggressive cleaning agents or solvents, nor store or install the unit in aggressive atmosphere to avoid damage to the employed plastics.

Cleaning must not take place in potentially explosive areas.

Ensure that the plastic housing is not electrostatically charged during cleaning. If this cannot be ensured, the housing must be discharged on all sides, outside the potentially explosive area, by means of a grounded metal plate before bringing the unit back into the potentially explosive area.

In explosive areas, the plastic housing must under no circumstances be exposed to handling or processes which can lead to electrostatic charging of the housing.

When removing the flowmeter and switch unit from the process line, ensure that no flow medium comes in contact with the switch housing and/or connecting cable.

The sensor side of the switch unit (opposite the cable entry) is fragile due to its function and must be protected against mechanical damages when removed from the flow meter.

The switch unit must be installed so that the connecting cable is not pinched, chafed or otherwise damaged and must not come in contact with parts which exceed temperatures of 75 °C (at T6) or 90 °C (at T5). The mounting of the switch unit onto flowmeters installed into a process line subjected to severe vibrations must be avoided, as this may cause malfunctions, such as loosening of the fixing screws, inexact measured values or cable failure.

The switch unit must not be employed in machinery, plants or medical apparatus in which, should a malfunction arise, persons, animals or property could be injured or damaged.

▪ **Function test**

Warning

The function test must be conducted outside the potentially explosive area.

SEM-A: The function test is performed with a cable tester and a magnet. If measured between core 1 and 2 of the connecting cable, the cable tester must switch from “conductive” to “nonconductive” when the magnet is in approximation to the front side of the switch unit. If measured between core 1 and 3 of the connecting cable the action of the cable tester must be reversed.

The dielectric resistance between the electrical connections and the housing must be $> 10 \text{ M}\Omega$.

| | | |
|--------------------|-------------------|------------------------|
| Connection: | Core No. 1 | Common |
| | Core No. 2 | Normally closed |
| | Core No. 3 | Normally open |

SEM-E: The function test is performed with a cable tester and a magnet. If the magnet is in approximation of the front side of the switch unit the cable tester must indicate “conductive” when the switch is triggered.

The dielectric resistance between the electrical connections and the housing must be $> 10 \text{ M}\Omega$.

Connection: In any order

Safety recommendation

The explosion proof safety can be increased when the switch unit is connected to an intrinsically safe circuit e. g. using a galvanic isolator with an intrinsically safe input circuit. The galvanic isolator must be mounted in the safe area.

Wiesen, 3 September 2018

EU-KONFORMITÄTSERKLÄRUNG

Wir,

Meister Strömungstechnik GmbH
Im Gewerbegebiet 2
DE 63831 Wiesen

erklären in alleiniger Verantwortung, dass unser Produkt

Grenzwertschalter Typ SEM-E und SEM-A

mit folgenden EU-Richtlinien übereinstimmt:

2014/34/EU – Geräte und Schutzsysteme zur Verwendung in explosionsgefährdeten Bereichen.

Hierzu angewandte Normen: EN 60079-0:2018 EN 60079-18:2015 + A1:2017
EN 60079-31:2014

Es sind keine wirksamen inneren Induktivitäten und Kapazitäten vorhanden.

Die EG-Baumusterprüfbescheinigung wurde erteilt von der Physikalisch – Technischen Bundesanstalt in Braunschweig Nr. PTB 03 ATEX 2154 X.

EG-Konformitätsaussage:
PTB 03 ATEX N055-5

EU-DECLARATION OF CONFORMITY

We,

Meister Strömungstechnik GmbH
Im Gewerbegebiet 2
DE 63831 Wiesen

hereby declare in our sole responsibility, that our product

Limit switch Type SEM-E and SEM-A

is in accordance with the following EU directives:

2014/34/EU Equipment and protective systems for use in potentially explosive atmospheres.

Standards applied here: EN 60079-0:2018 EN 60079-18:2015 + A1:2017
EN 60079-31:2014

There are no effective internal inductivities and capacities present.

EC-Type Examination Certificate granted by the Physikalisch – Technische Bundesanstalt Braunschweig (Germany) no. PTB 03 ATEX 2154 X

EC-Certificate of Conformity:
PTB 03 ATEX N055-5

Wiesen 22 November 2018

Legally binding signature of authorized person



Rosemarie Mill

4 Operating data

Operating data for employment in explosion-hazard zones.

4.1 Operating data for the mechanical component of the device

The maximum operating pressure is specified in Chapter 10.7 of the Operating Instructions for "DWG-L Module BASICS".

The maximum media and ambient temperatures for the mechanical component depend on various factors. It is the responsibility of the operator to specify the maximum temperatures within the framework set by the guidelines in  Chapter 3.1.4 "Categorization of the mechanical component of the flow monitor" on page 16 of these Operating Instructions.

4.2 Switch contact operating data

Operating data for the explosion-proof switch unit with design examination certificate (PTB 03 ATEX 2154 X).

The following limit values must not be exceeded, not even for brief periods:

Table 1: Normally Open Contact (NOC), SEM-E (T6)

| | |
|---|-------|
| Max. operating voltage | 250 V |
| Max. switch current | 2 A |
| Max. switching capacity | 60 VA |
| Max. ambient temp for switch contact | 75 °C |

Table 2: Normally Open Contact (NOC), SEM-E (T5)

| | |
|---|-------|
| Max. operating voltage | 250 V |
| Max. switch current | 2 A |
| Max. switching capacity | 60 VA |
| Max. ambient temp for switch contact | 90 °C |

Table 3: Change-Over Contact, SEM-A (T6)

| | |
|---|-------|
| Max. operating voltage | 250 V |
| Max. switch current | 1 A |
| Max. switching capacity | 30 VA |
| Minimum load | 3 VA |
| Max. ambient temp for switch contact | 75 °C |

Table 4: Change-Over Contact, SEM-A (T5)

| | |
|---|-------|
| Max. operating voltage | 250 V |
| Max. switching current | 1 A |
| Max. switch capacity | 30 VA |
| Minimum load | 3 VA |
| Max. ambient temp for switch contact | 90 °C |

5 Transport, packaging and storage

Transport, packaging and storage in non-explosion-hazard zones are described in Chapter 4, "DWG-L Module BASICS".

In explosion-hazard zones, in addition to the requirements described in the above reference, all valid provisions for safety, accident prevention and environmental protection must be complied with.

Packaging procedures (wrapping/unwrapping) may only be conducted outside the explosion-hazard zone.



DANGER!

Danger to life if packaging procedures are conducted in explosion-hazard zones.

- Packaging procedures may only be conducted outside the explosion-hazard zone.

6 Installation and initial startup

Installation and initial startup in non-explosion-hazard zones are described in Chapter 5, "DWG-L Module BASICS". In addition, for installation and initial startup in explosion-hazard zones, the following sections must be observed:

6.1 Safety

All relevant safety-, accident prevention- and environmental protection regulations must be followed for employment in an explosion hazard zone.

6.2 Tools

Tools, which may cause sparks, are not to be employed. These tools may only be used when there is no potentially explosive atmosphere present.

The use of steel tools, of any kind, is prohibited in hazard zone 1, if there is risk of explosion due to substances in explosion hazard group IIC (in accordance with IEC/TR3 60079-20), (for example, acetylene, hydrogen).

6.3 Protection of the sight glass

The flow monitor with sight glass must be installed in such a way as to preclude damage to the sight glass by outside force.

The facility operator is responsible for the installation of an appropriate impact protection shield.

6.4 Electrical connection

Electrical connection is accomplished through the cast on power cable leading from the switch housing. All safety advisories contained in the Operating Instructions for "DWG-L Module BASICS", Chapter 5, must be observed. Additionally, for operation in explosion-hazard zones, all valid provisions for safety, accident prevention and environmental protection must be complied with.

6.5 Grounding the device

When installing the device in a pipe system, ensure that the device is grounded to the pipe system to avoid a dangerous electrical potential difference.

6.6 Contact protection measures

Recommendations for contact protection measures, when the device is employed in a non-explosion-hazard zone, are described in chapter 5.9 "Contact protection measures" of the Operating Instructions for "DWG-L Module BASICS". When the device is employed in an explosion-hazard zone, only those contact protection measures may be taken, which are

consistent with all valid safety and accident prevention measures for explosion-hazard zones and the specifications contained in these Operating Instructions.

7 Operation

Operation is described in Chapter 6, "DWG-L Module BASICS". All safety- and hazard warnings contained in Chapter 6, "DWG-L Module BASICS", must be followed. For operation in explosion-hazard zones, all valid provisions for safety, accident prevention and environmental protection must be complied with.

8 Troubleshooting

The procedures in case of malfunction are described in Chapter 7, "DWG-L Module BASICS". All safety- and hazard warnings, contained in Chapter 7, "DWG-L Module BASICS", must be followed. Additionally, for operation in explosion-hazard zones, all valid provisions for safety, accident prevention and environmental protection must be complied with.

9 Maintenance

Maintenance procedures are described in Chapter 8, "DWG-L Module BASICS". All safety- and hazard warnings, contained in Chapter 8, "DWG-L Module BASICS", must be followed. For operation in explosion-hazard zones, all valid provisions for safety, accident prevention and environmental protection must be complied with. Maintenance procedures may only be performed outside the explosion-hazard zone.



DANGER!

Danger to life if maintenance procedures are performed in the explosion-hazard zone

- Maintenance procedures may only be performed outside the explosion-hazard zone

9.1 Return Materials

9.1.1 Return Materials Authorization

For products being returned, regardless of the reason, the currently valid provisions of the returns policy set by MEISTER will apply. Return shipments which do not comply with the returns policy may be refused by MEISTER at the expense of the consignor.

10 Disassembly and disposal

Disassembly and disposal procedures are described in Chapter 9, "DWG-L Module BASICS". All safety- and hazard warnings, contained in Chapter 9, "DWG-L Module BASICS", must be followed. For operation in explosion-hazard zones, all valid provisions for safety, accident prevention and environmental protection must be complied with. Disassembly of the device may only be performed outside the explosion-hazard zone.



DANGER!

Danger to life if disassembly procedures are performed in the explosion- hazard zone

- Disassembly may only be performed outside the explosion hazard zone
- Disassembly in an explosion hazard zone may only be performed if there is no risk from an explosive atmosphere

11 Technical data

11.1 Dimension sheet

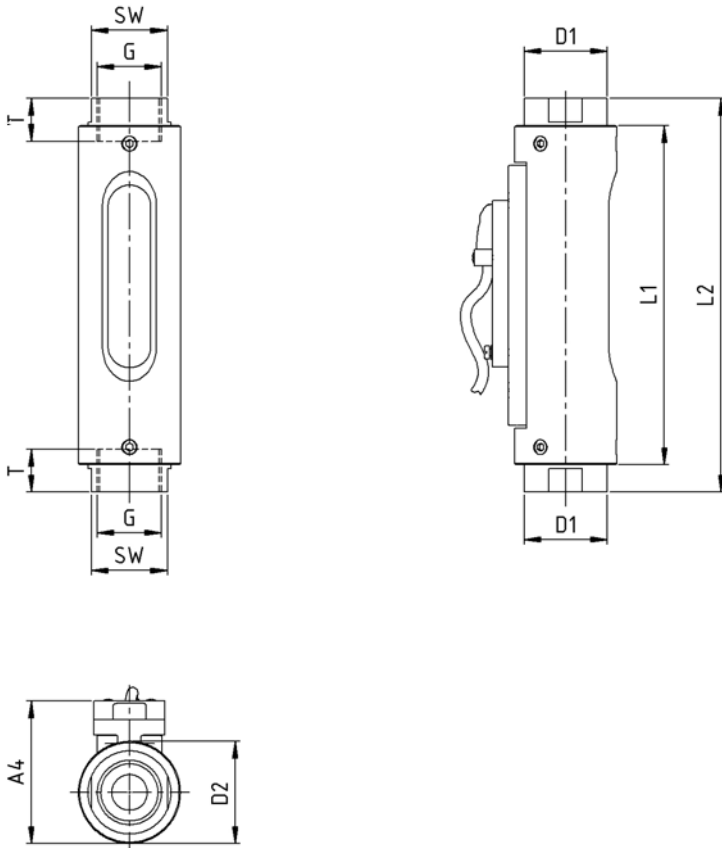

11.2 General specifications

| Type | Overall dimensions (mm) | | | | | |
|----------|-------------------------|----|----|-----|-----|----|
| | G | DN | SW | L1 | L2 | T |
| DWG-L1,5 | 1/4" | 8 | 32 | 121 | 132 | 10 |
| | 3/8" | 10 | 32 | 121 | 135 | 15 |
| | 1/2" | 15 | 32 | 121 | 135 | 14 |
| DWG-L3 | 1/4" | 8 | 32 | 121 | 132 | 10 |
| | 3/8" | 10 | 32 | 121 | 135 | 15 |
| | 1/2" | 15 | 32 | 121 | 135 | 14 |
| DWG-L8 | 1/4" | 8 | 32 | 121 | 132 | 10 |
| | 3/8" | 10 | 32 | 121 | 135 | 15 |
| | 1/2" | 15 | 32 | 121 | 135 | 14 |
| DWG-L12 | 1/4" | 8 | 32 | 121 | 132 | 10 |
| | 3/8" | 10 | 32 | 121 | 135 | 15 |
| | 1/2" | 15 | 32 | 121 | 135 | 14 |
| DWG-L18 | 1/2" | 15 | 32 | 143 | 161 | 14 |
| | 3/4" | 20 | 32 | 143 | 166 | 15 |
| DWG-L35 | 3/4" | 20 | 41 | 143 | 163 | 15 |
| | 1" | 25 | 41 | 143 | 163 | 17 |
| DWG-L50 | 3/4" | 20 | 41 | 143 | 163 | 15 |
| | 1" | 25 | 41 | 143 | 163 | 17 |
| DWG-L100 | 1" | 25 | 41 | 143 | 163 | 17 |

| Type | Overall dimensions (mm) | | | | | | | |
|---|-------------------------|----|----|----|----|----|--------|------------|
| | G | D1 | D2 | A1 | A2 | A3 | A4 | Weight (g) |
| DWG-L1,5 | 1/4" | 35 | 43 | - | - | - | ca. 60 | 800 |
| | 3/8" | 35 | 43 | - | - | - | ca. 60 | 800 |
| | 1/2" | 35 | 43 | - | - | - | ca. 60 | 800 |
| DWG-L3 | 1/4" | 35 | 43 | - | - | - | ca. 60 | 800 |
| | 3/8" | 35 | 43 | - | - | - | ca. 60 | 800 |
| | 1/2" | 35 | 43 | - | - | - | ca. 60 | 800 |
| DWG-L8 | 1/4" | 35 | 43 | - | - | - | ca. 60 | 800 |
| | 3/8" | 35 | 43 | - | - | - | ca. 60 | 800 |
| | 1/2" | 35 | 43 | - | - | - | ca. 60 | 800 |
| DWG-L12 | 1/4" | 35 | 43 | - | - | - | ca. 60 | 800 |
| | 3/8" | 35 | 43 | - | - | - | ca. 60 | 800 |
| | 1/2" | 35 | 43 | - | - | - | ca. 60 | 800 |
| DWG-L18 | 1/2" | 35 | 43 | - | - | - | ca. 60 | 800 |
| | 3/4" | 35 | 30 | - | - | - | ca. 60 | 960 |
| DWG-L35 | 3/4" | 45 | 50 | - | - | - | ca. 68 | 1450 |
| | 1" | 45 | 50 | - | - | - | ca. 68 | 1450 |
| DWG-L50 | 3/4" | 45 | 50 | - | - | - | ca. 68 | 1450 |
| | 1" | 45 | 50 | - | - | - | ca. 68 | 1450 |
| DWG-L100 | 1" | 45 | 50 | - | - | - | ca. 68 | 1450 |
| * NPT thread on request | | | | | | | | |
| ** Sealed-in cable weight, 2m approx. 80g | | | | | | | | |

11.3 Replacement parts

The following replacement parts drawing provides an example of the configuration of a DWG-L ATEX flow monitor. The actual configuration may vary depending on the model.

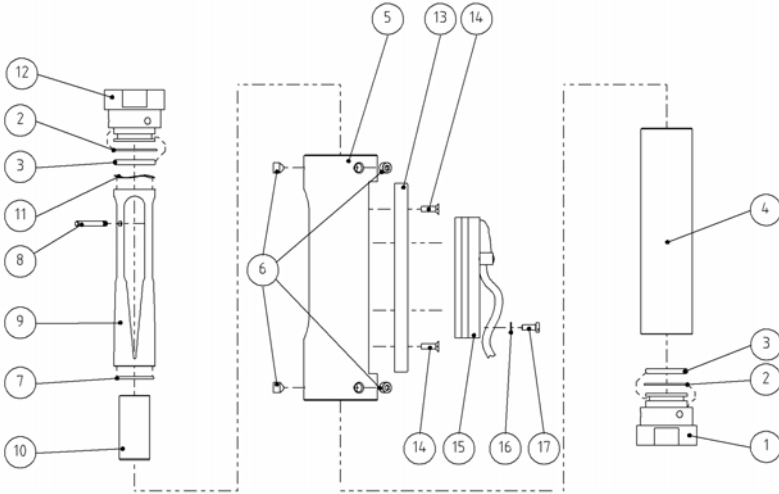

| Item | Qty | Description |
|------|-----|-----------------------------|
| 1 | 1 | Process connection (inlet) |
| 2 | 2 | O-ring (glass buffer) |
| 3 | 2 | O-ring (seal) |
| 4 | 1 | Sight glass |
| 5 | 1 | Device body |
| 6 | 6 | Hex socket screw |
| 7 | 1 | O-ring (slot nozzle buffer) |

| Item | Qty | Description |
|-------------|------------|-----------------------------|
| 8 | 1 | Pin (slot nozzle outlet) |
| 9 | 1 | Slot nozzle |
| 10 | 1 | Float |
| 11 | 1 | Wave-spring washer |
| 12 | 1 | Process connection (outlet) |
| 13 | 2 | Guide rail |
| 14 | 4 | Fixing screw (guide rail) |
| 15 | 1 | Switch contact with cable |
| 16 | 2 | Washer |
| 17 | 2 | Set screw (switch contact) |

12 Annex

The required tools are specified in Chapter 11.3 "Tools" of the Operating Instructions for "DWG-L Module BASICS".

In explosion-hazard zones, tools which may cause sparks, are not to be employed. These tools may only be employed when there is no potentially explosive atmosphere present.

The use of steel tools, of any kind, is prohibited in hazard zone 1, if there is a risk of explosion due to substances in explosion hazard group IIC (in accordance with IEC/TR3 60079-20), (for example, acetylene, hydrogen).

13 Index

A

Applicable Documents 24
 Application 8
 Atmosphere 24

C

Categorization 24
 mechanical component 16
 Contact 6
 Contact protection measures 37
 Copyright 3
 Correct use in explosion-hazard zones 8
 Customer service 6

D

Device
 electrical component 24
 exterior 14
 interior 14
 Device category 24
 Device group 24
 Disassembly 42
 disposal 42

E

Electrical connection 37
 Environmental protection regulations 37

G

General
 safety 7
 Grounding 37

I

Ignition protection category 24
 Initial start-up 37
 Installation 37

L

Limitation of liability 3
 Limiting contacts 24
 List of media 19

M

Maintenance 41

O

Operating data
 mechanical component 34
 switch contact 34
 Operation 39

P

Packaging 36
 Personnel 13
 Precautions
 explosions 11
 general 10
 Protective Systems 13

R

| | |
|--------------------------------------|----|
| Replacement parts | 46 |
| Return Materials Authorization . . . | 41 |

S

| | |
|--------------------------------|----|
| Safety equipment | 13 |
| Safety information | |
| mechanical component | 15 |
| Safety regulations | 37 |
| Service | 6 |
| Sight glass | |
| protection | 37 |
| Storage | 36 |
| Symbols used | |
| in the instructions | 7 |

T

| | |
|---|--------|
| Technical data | |
| Dimension sheet | 43 |
| general specifications | 44 |
| Temperature class | 24 |
| Temperature class internal: T6, external: T6 | 18 |
| Tools | 37, 48 |
| Transport | 36 |
| Troubleshooting | 40 |

W

| | |
|-----------------------------------|---|
| Warranty and guarantee provisions | 6 |
|-----------------------------------|---|