

Operating instructions

TDHK-25I/MS

Turbine-Flowmeter



meister 

Series TDH...

Type TDHK-25I/MS

Read this manual prior to performing any task!

Meister Strömungstechnik GmbH
Im Gewerbegebiet 2
63831 Wiesen
Telephone: +49 6096 9720 - 0
Fax: +49 6096 9720 - 30
E-mail: sales@meister-flow.com
Internet: www.meister-flow.com

TDHK-25I/MS.01, 1, en_US

These operating instructions were compiled by:
Meister Strömungstechnik GmbH
Subject to change without notice

© Meister Strömungstechnik GmbH 2018

These instructions facilitate the safe and efficient handling of a flowmeter (referred to as "device" in the following). The instructions are an integral part of the device and must be kept within easy reach for the personnel in the immediate vicinity of the device at all times. Personnel must carefully read and understand these instructions before commencing all work. The basic requirement for safe work is adherence to all safety and handling instructions stipulated in these instructions. The local accident-prevention regulations and general safety standards and regulations for the field of application of the device also apply. Illustrations in these instructions are provided to aid general understanding and might deviate from the actual model. No claims can be derived from any such differences.

Limitations of liability

All details and instructions in this manual have been compiled under consideration of the valid standards and regulations, the current state-of-technology and our many years of knowledge and experience. The manufacturer does not accept any liability arising from:

- non-observance of any details in these instructions
- improper use of the device, or use that is not in accordance with these instructions
- use of non-trained personnel

- unauthorized retrofitting or technical changes that have not been authorized by the manufacturer
- use of non-approved replacement parts

The duties and obligations agreed upon in the delivery contract apply in full, as well as the general terms and conditions, the terms of delivery by the manufacturer and the valid legal regulations applicable at the conclusion of the contract.

Copyright

These operating instructions are protected by copyright.

Except for internal purposes, transfer of these instructions to third-parties, copying them in any way – even in part – as well as dissemination and/or communication of their content is forbidden without prior written authorization from Meister Strömungstechnik ("manufacturer"). Violations are subject to claims for indemnification. The manufacturer reserves the right to assert additional claims.

Copyright is the property of the manufacturer.

© Meister Strömungstechnik GmbH

Im Gewerbegebiet 2
63831 Wiesen
Germany

Table of contents

1	Overview	8
	1.1 Short description.....	8
	1.2 Warranty and guarantee provisions.....	8
	1.3 Customer service.....	8
2	Safety	9
	2.1 Explanation of symbols.....	9
	2.2 Correct use in accordance with these instructions.....	10
	2.3 Special precautions.....	12
	2.3.1 Hazards from electrical current.....	12
	2.3.2 Mechanical hazards.....	13
	2.3.3 Hazards from high or low temperatures.....	14
	2.3.4 Radiation hazards.....	14
	2.3.5 Hazards caused by media.....	15
	2.4 Personnel requirements.....	15
	2.5 Personal safety equipment.....	16
	2.6 Protective systems.....	17
	2.7 Environmental protection.....	17
	2.8 Responsibility of the owner.....	18
3	Design and function	20
	3.1 Overview.....	20
	3.2 Device description.....	21
4	Transport, packaging and storage	22
	4.1 Safety instructions for transport.....	22
	4.2 Transport inspection.....	22
	4.3 Packaging.....	22
	4.4 Symbols on the shipping box.....	23
	4.5 Storage.....	23
5	Installation and initial startup	25
	5.1 Safety.....	25
	5.2 Requirements at the place of installation.....	25
	5.3 Preparatory work.....	26

5.4	Installation in the pipe system.....	28
5.5	Initial startup.....	32
5.6	Electrical connection.....	33
5.6.1	Connection diagram.....	35
6	Operation.....	36
6.1	Adjusting the measuring range.....	36
6.2	Pulse characteristics.....	37
7	Troubleshooting.....	38
7.1	Safety.....	38
7.2	Troubleshooting guide.....	40
8	Maintenance.....	41
8.1	Maintenance table.....	41
8.1.1	Cleaning.....	42
9	Disassembly and disposal.....	44
9.1	Safety.....	44
9.2	Removal from the pipe system.....	44
9.3	Disassembly.....	46
9.4	Disposal.....	47
9.5	Return Materials.....	48
9.5.1	Return Materials Authorization.....	48
10	Technical data.....	49
10.1	Device data plate.....	49
10.2	Dimension sheet.....	50
10.3	General specifications.....	50
10.3.1	Installation data.....	52
11	Annex.....	55
11.1	Sealant.....	55
12	Index.....	56

List of figures

Fig. 1:	Flowmeter TDH...-25I / MS....	8
Fig. 2:	Front view.....	20
Fig. 3:	Connection diagram.....	35
Fig. 4:	Pulse characteristics.....	37
Fig. 5:	Flushing and cleaning the device.....	42
Fig. 6:	Device data plate.....	49
Fig. 7:	Dimension sheet	50
Fig. 8:	Pulse characteristics.....	53
Fig. 9:	Pressure drop.....	53
Fig. 10:	Connection diagram.....	54

List of tables

Table 1: Correct use in non-hazard areas.....	11
Table 2: Operating data.....	50
Table 3: Electrical data.....	51
Table 4: Measuring ranges (for H ₂ O at 20 °C / 68 °F).....	52

1 Overview

1.1 Short description



Fig. 1: Flowmeter TDH...-25I / MS

Flowmeters of the series TDH... measure the flow by using a turbine, which has been fitted with magnets. The rotational speed of the turbine is sampled with a Hall sensor. It is then converted into a square wave signal by the integrated electronics. The signal is proportional to the flow.

1.2 Warranty and guarantee provisions

Warranty and guarantee provisions are contained in the general terms and conditions of Meister Strömungstechnik.

1.3 Customer service

For technical support, please contact our customer service department (for contact details, see Page 2).

Furthermore, our staff is always interested in receiving new information and experiences gained from application of the device, which may be useful in improving our products.

2 Safety

This chapter provides an overview of important safety aspects required for optimum protection of personnel as well as for safe installation and safe operation of the device.

Non-observance of the handling and safety instructions listed in this manual may result in hazardous/dangerous conditions and in damage to property.

2.1 Explanation of symbols

Safety instructions

Safety instructions in this manual are marked by symbols. The safety instructions are preceded by signal words that indicate the level of danger/hazard.

To prevent accidents or injury to persons as well as damage to property, always observe the safety instructions and proceed carefully.



DANGER!

This combination of symbol and signal word indicates an immediate, dangerous condition that results in death or serious injury if it is not avoided.



WARNING!

This combination of symbol and signal word indicates a possibly dangerous condition that might result in death or serious injury if it is not avoided.



CAUTION!

This combination of symbol and signal word indicates a possibly dangerous condition that might result in minor or slight injury if it is not avoided.



NOTICE!

This combination of symbol and signal word indicates a possibly dangerous condition that might result in damage to property and to the environment if it is not avoided.

- ➔ Designates step-by-step handling instructions
 - ⇒ Designates a state or an automatic sequence as a result of a specific operating step
- Designates randomly ordered enumerations and list entries
- ↪ “Signs used in these instructions” on page 10, designates references to chapters in these instructions

2.2 Correct use in accordance with these instructions

Tips and recommendations



This symbol emphasizes useful tips and recommendations as well as information for efficient and failure-free operation.

The device has been designed and constructed solely for the correct use in accordance with these instructions.

Signs used in these instructions

The following signs and highlightings are used in these instructions to identify handling instructions, the description of results, lists/enumerations, references and other elements:



DANGER!

The Fahrenheit and PSI measurement units in these operating instructions have been rounded down for easier readability!

Always refer to the metric units for calculations and dimensioning of e.g. the pipe system!

Table 1: Correct use in non-hazard areas

The flowmeters type TDHK-25I/MS serve exclusively to monitor the continuous flow of liquids within a temperature range of 0 °C to 85 °C / 32 °F to 185 °F at a maximum operating pressure of 10 bar / 144 psi.

Correct use in explosion-hazard zones



DANGER!

This device is not certified for the use in explosion-hazard zones!



WARNING!

Danger due to incorrect use!

Incorrect use of the flowmeter may result in dangerous conditions

- Use the flowmeter only within the stipulated performance limits
- Do not subject the flowmeter to severe temperature fluctuations
- Do not use the flowmeter with quick-acting valves
- Do not use the flowmeter with solenoid valves
- Do not subject the flowmeter to vibrations
- Do not subject the flowmeter to pressure surges
- Do not use the flowmeter with media containing solids or abrasives
- Use the flowmeter only with media previously approved by the manufacturer
- Do not use the flowmeter as the sole monitoring device to prevent dangerous conditions
- Do not install the flowmeter as a load bearing part within a pipeline system

All claims for damages due to incorrect usage are excluded.

2.3 Special precautions

The following section lists residual risks which might arise from the device.

WARNING!

To reduce health risks and prevent dangerous conditions, observe the safety instructions listed here as well as the safety instructions in the other chapters of these operating instructions..



These Operating Instructions cannot cover all conceivable dangers because many dangers arise, not from the device itself, but from the respective media flowing through it. Always observe the appropriate safety data sheets when using hazardous media!

2.3.1 Hazards from electrical current

Electrical current

DANGER!

Danger to life from electrical current!

There is an immediate risk to life from electrocution on touching live parts. Damaged electrical insulation or components can be extremely dangerous..

- Only qualified electricians shall work on the electrical system.
- If the insulation is damaged, immediately switch off and have repairs performed.
- Before commencing work on live parts of the electrical systems and operating equipment, disconnect the equipment and ensure that it remains disconnected for the duration of the work. Observe these 5 safety rules when doing so:
 - Isolate (disconnect)
 - Secure against switching back on
 - Check for absence of voltage
 - Ground and short

- Cover or cordon off other live parts in the vicinity
- Never bridge fuses or put them out of operation. Always observe the correct current ratings when replacing fuses
- Keep moisture away from live parts. This can result in short-circuit

2.3.2 Mechanical hazards



WARNING!

Risk of injury due to fractured housing and leakage!

Unauthorized temperatures or excessive pressure may cause the flowmeter body or the process connections to burst. Injuries may be caused by flying parts and escaping media.

- Keep within the stipulated operating conditions
- Wear personal protective equipment
- Avoid severe temperature fluctuations
- Avoid pressure surges



WARNING!

Risk of injury on sharp edges and pointed corners!

Sharp edges and pointed corners can cause abrasions and skin cuts

- Proceed with caution when working near sharp edges and pointed corners
- If in doubt, wear protective gloves

2.3.3 Hazards from high or low temperatures

Hot or cold surfaces



WARNING!

Risk of injury from hot or cold surfaces!

Surfaces of components may heat up or cool down dramatically due to the media flowing through them. Skin contact with hot or cold surfaces may cause severe skin burn or frostbite.

- Always wear temperature-resistant protective work clothing and protective gloves when working near hot or cold surfaces
- Before commencing work, make sure that all surfaces have been cooled down or warmed up to ambient temperature

2.3.4 Radiation hazards

Strong magnetic fields



WARNING!

Danger to life from strong magnetic fields!

Strong magnetic fields may cause severe injury or even be fatal, as well as cause considerable damage to property.

- Persons with pacemakers must not be located in the vicinity of the device. This could impair the function of the pacemaker
- Persons with metal implants must not be located in the vicinity of the device. Implants can heat up or be attracted magnetically
- Keep ferromagnetic materials and electromagnets away from the magnetic source. These materials could be attracted and fly through the room, thereby injuring or even killing persons. Minimum clearance: 3 m
- Remove and put away metal objects before maintenance work (jewelry, watches, writing implements, etc.)

- Do not place any electronic devices within the vicinity of the magnetic source. These could be damaged
- Do not place any electronic storage media, credit cards, etc. within the vicinity of the magnetic source. Data could be deleted

2.3.5 Hazards caused by media

Hazardous media



Risk of injury from hazardous media!

If the flow monitor is used for toxic, corrosive or very hot or cold media, there is a risk of serious injury from escaping media.

- Observe details in the safety data sheet of the media
- Comply with the safety, accident prevention and environmental protection regulations appropriate to the media used
- Wear personal protective equipment in accordance with the safety data sheet

2.4 Personnel requirements



Risk of injury due to insufficiently trained and qualified personnel!

If unqualified personnel work on the device or are located within its hazard zone, dangers arise which may result in serious injury and considerable damage to property.

- All work must be performed by qualified personnel only.
- Keep unqualified personnel away from hazard zones.

Authorized personnel is to be restricted to those persons who can be expected to perform their work reliably. Persons whose ability to respond is influenced, e.g. by drugs, alcohol or medication, are not authorized.

Observe the age and occupational regulations at the site when choosing personnel.

The following lists the personnel qualifications for the various areas of activity:

Qualified electrician

Due to specialized training, knowledge and experience as well as knowledge of the relevant standards and regulations, the qualified electrician is able to independently perform work on the electrical systems as well as to detect and avoid possible risks and dangers.

Additionally, the electrician must provide proof of his/her professional qualification that certifies his/her ability to perform work on electrical systems.

The qualified electrician must fulfill the requirements contained in the valid legal accident-prevention regulations.

Qualified personnel

Due to their specialized training, knowledge and experience as well as their knowledge of the relevant standards and regulations, qualified personnel are able to independently perform the work assigned to them as well as to detect and avoid possible risks and dangers.

2.5 Personal safety equipment

Personal safety equipment is used to protect personnel from hazards or dangers that might impair their safety or health during work.

When performing the various tasks at, and with the device, personnel must wear personal safety equipment. Special reference is made of this in the individual chapters within these Operating Instructions. The following provides a description of the personal safety equipment:

- Always wear appropriate personal safety equipment required in the various chapters of these Operating Instructions before commencing work.
- Comply with the personal safety equipment instructions posted within the work area.

Description of personal safety equipment

As specified in the Safety Data Sheet of the medium, protective equipment must be worn when handling hazardous media. In addition, the specifications of the system operator must be followed. If no protective equipment is specified, suitable protective gloves and goggles must be worn.

The protective equipment is used to protect against hazardous media leaks and hazardous media residue in the device.

Goggles



The goggles are used to protect the eyes from flying debris and splashing fluid.

Protective gloves



Protective gloves protect the hands from friction, burns, grazing, abrasion, surface cuts or deeper injuries, as well as from direct contact with hot or cold surfaces.

2.6 Protective systems

Integration within an emergency-stop concept is required

The device is designed for use as a part of a machine or system. It does not have its own controller and does not have an autonomous emergency-stop function.

Before starting up the device, install the emergency-stop equipment and incorporate it into the safety chain of the machine or system.

Connect the emergency-stop equipment so that if there is an interruption in the power supply or in the activation of the power supply after an interruption, dangerous conditions are excluded for persons and valuables.

The emergency-stop equipment must always be freely accessible.

2.7 Environmental protection

! NOTICE!

Risk to the environment due to improper handling of environmentally hazardous substances!

Serious environmental damage may result if substances harmful to the environment are handled incorrectly, especially if they are disposed of improperly.

- Always observe the instructions listed below on the handling and disposal of substances harmful to the environment.
- If harmful substances are released into the environment, take immediate countermeasures. If there is doubt, contact the local authorities, inform them of the damage and request information on suitable countermeasures to be taken.

Cleaning fluids

Solvent-based cleaning fluids contain toxic substances. They must never be released into the environment and must be disposed of by a waste management company.

2.8 Responsibility of the owner

Owner

The owner is the person who operates the device himself for business or commercial purposes or who cedes such use/application to a third-party and who, during operation of the device, has full legal product stewardship for protection of the user, the personnel or third-parties.

Duties of the owner

The device is used in the commercial sector. The owner of the device is therefore subject to legal obligations pertaining to work safety.

In addition to the safety instructions contained in these Operating Instructions, the safety, accident prevention and environmental protection regulations applicable to the field of application of the device must be observed.

In particular, this includes:

- The owner must inform himself regarding the valid health and safety regulations and must perform a risk assessment to additionally determine the risks resulting from the special work conditions arising at the location at which the device is used, especially in regard to the media used. He must then implement these within Operating Instructions for use of the device.
- **For the USA:**

The "Occupational Health and Safety Act" of 1970 stipulates that it is the duty of the owner to provide a safe workplace. He must hereby ensure that the device is operated and maintained compliant to valid commercial, industrial, local, federal and state laws, standards and regulations.
- **For Canada:**

The "Canadian Centre for Occupational Health and Safety Act" of 1978 stipulates that all Canadians have "...a fundamental right to a healthy and safe working environment." It is therefore the duty of the owner to provide a safe workplace. He must ensure that the device is operated and maintained compliant to valid commercial, industrial, local, provincial, territorial and federal laws, standards and regulations.
- Appropriate to the working conditions and the media used, the owner must affix signs within the working area that inform the user of the hazards and dangers present.
- During the entire period of use of the device, the owner must check periodically to ensure that the Operating Instructions correspond to the current state of regulations, and he must make adjustments as necessary.
- The owner must clearly regulate and determine responsibilities for installation, operation, troubleshooting, maintenance and cleaning.

- The owner must fit/retrofit suitable safety equipment within the complete plant/system.
- The owner must ensure that all staff/personnel have thoroughly read and understand these instructions before handling the device. Additionally, he must train the personnel at regular intervals and warn them of dangers.
- The owner must provide the personnel with the required safety equipment and must instruct them that its wear is mandatory.

Additionally, the owner is responsible for ensuring that the device is always kept in a technically perfect condition. The following therefore applies:

- The owner must implement suitable safety measures, appropriate to the media used.
- Different media have different severities of influence on the soiling and wear of/to the device. The owner must set suitable maintenance intervals, depending on the media flowing through the device.
- The owner must ensure that the maintenance intervals described in these Operating Instructions are adhered to at all times.
- The owner must ensure that the device is completely free of all residual media before disposal. Remains of corrosive or toxic materials must be neutralized.

3 Design and function

3.1 Overview

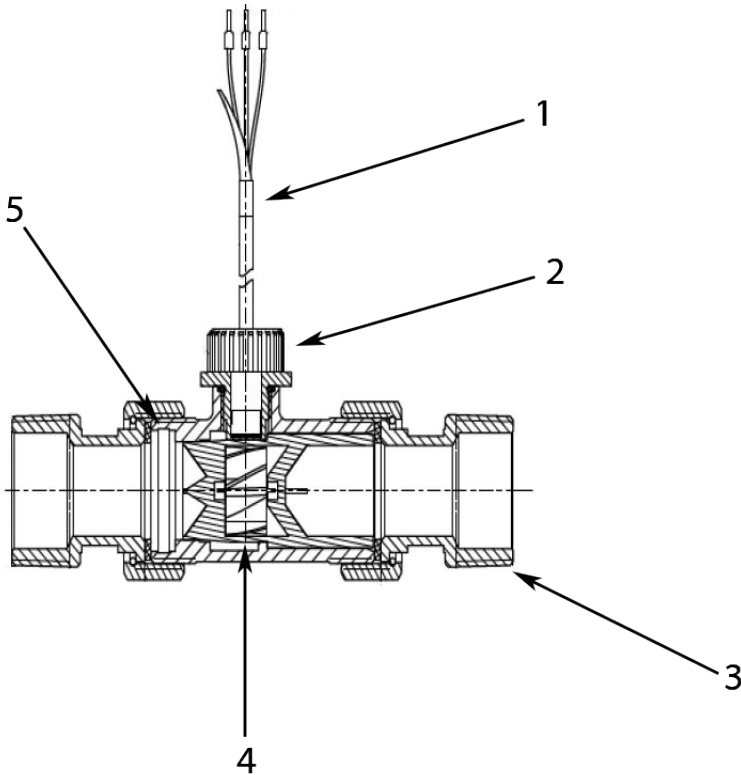

Fig. 2: Front view

1 Connecting cable
2 Knurled union nut

3 Process connection (Connection adapter)
4 Turbine wheel
5 Stabilizer

3.2 Device description

Flowmeters of the series TDH measure the flow by means of a turbine. The turbine has been fitted with magnets. The rotational speed of the turbine is sampled with a Hall sensor. The rotational speed is then converted by the integrated electronics into evaluable electric current. The flowmeter is installed into a pipeline. It measures the flow of the medium through the pipeline.

An exceptionally high longevity is achieved through the use of high quality sapphire bearings.

Range of applications for the TDH-flowmeters include medical engineering, pharmaceutical industry, chemical industry as well as research & development.

4 Transport, packaging and storage

4.1 Safety instructions for transport

Improper transport

NOTICE!

The device could be damaged if transported improperly!

Objects to be transported may fall or overturn if transported improperly. This may result in damage to the device and/or property.

- Proceed carefully when unloading transported packages, both on delivery and when transporting in-house. Observe the symbols and instructions on the shipping box
- Remove packaging material just prior to assembly

4.2 Transport inspection

On delivery, make an immediate check for completeness and check for transport damages.

If there are any visible external transport damages, proceed as follows:

- Do not accept the delivery
- Note the damage in the shipping documents or on the delivery note of the transporter and have the driver confirm by signature
- Initiate a claim for damages



Make a claim for each fault as soon as it is detected. Claims for damages can only be invoked within the valid claim periods.

4.3 Packaging

Packaging

The packaging serves to protect the individual components from transport damages, corrosion and other damages until they are installed. Do not discard the packaging and only remove the device from the shipping box immediately before installation.

Handling packaging materials

Dispose of packaging material in accordance with the valid legal regulations and local ordinances.

! NOTICE!

Danger to the environment due to incorrect disposal!

Packaging is made of valuable raw materials and can be reused in many cases or usefully processed and recycled. Improper disposal of packaging materials may pose a danger to the environment.

- Dispose of packaging material in an environmentally safe manner
- Comply with the local disposal regulations. If necessary, have the packaging disposed of by approved specialists.

4.4 Symbols on the shipping box

Top



The arrows indicate the top side of the package. They must always point upwards, otherwise the content may be damaged.

Fragile



Designates packages with breakable or damageable contents.

Handle the package carefully and do not allow it to fall or be subjected to jarring or severe vibration.

4.5 Storage

Storing the packages

Store the packages under the following conditions:

- Do not store in the open
- Store dry and dust-free
- Do not subject to any aggressive media
- Protect from direct sunlight
- Avoid mechanical vibrations and shocks
- Storage temperature: 0 to 35 °C / 32 °F to 95 °F
- Relative humidity: max. 60 %
- Do not stack
- If storing for longer than 3 months, regularly check the general condition of all parts as well as of the packaging.



Storage instructions in addition to the instructions listed here may be listed on the packages. Follow these instructions also.

5 Installation and initial startup

5.1 Safety

Incorrect installation and initial startup



WARNING!

Risk of injury due to incorrect installation and initial startup!

Incorrect installation and initial startup may result in severe injury and considerable damage to property.

- Ensure that the site is sufficiently cleared of obstructions before commencing work
- Handle open or sharp edged components carefully
- Ensure that the assembly location is orderly and clean! Parts and tools lying about or on top of each other are potential causes for accidents
- Assemble components properly. Observe the stipulated tightening torque of screws
- Before initial startup, make sure that all installation work has been performed and completed in compliance with the specifications and instructions in these Operating Instructions

Safeguard against restart



WARNING!

Danger to life due to unauthorized restart!

There is a risk of severe or even fatal injury due to unauthorized restart of the power supply during installation.

- Before commencing work, switch off the power supply to the entire system/plant and secure against restart

5.2 Requirements at the place of installation

The place of installation must meet the following requirements:

- The device must not be under water.
- The surrounding area must be sufficiently illuminated.
- There must be sufficient space to prevent accumulation of trapped heat.
- The device must not be installed as a supporting part in a pipe construction.
- The device may not have anything affixed to, or suspended from it.

- The flow monitor must be installed in such a way as to preclude damage by outside force. It must be ensured that the flow monitor cannot be damaged. If necessary, install an appropriate impact protection device.
- External magnetic fields will influence the switch contact. Keep sufficient distance to magnetic fields (e.g. electric motors).
- Piping, process connections or supports made of ferromagnetic material influence the magnetic field of the device. Keep a space of at least 100 mm to those materials (e.g. steel).

5.3 Preparatory work

The following requirements must be met during installation to ensure correct functioning of the flowmeter:

WARNING!

Danger due to incorrect installation!

If the requirements listed below are not observed when installing the flowmeter, dangerous/hazardous conditions may arise.

- Do not install the flowmeter as a supporting part in a pipe system
- Do not use the flowmeter with quick-acting valves
- Do not use the flowmeter with solenoid valves

Air pockets / Cavitation

NOTICE!

Prevent air pockets and cavitation!

The formation of air pockets and cavitations must be prevented by appropriate means. These can damage or destroy the flowmeter.

Anti-freeze / anti-corrosive fluids

WARNING!
Damage caused by anti-freeze/anti-corrosive fluids

Anti-freeze/anti-corrosive fluids must be checked for compatibility prior to use! The manufacturer cannot be held liable for any damages caused by incompatibility of the anti-freeze/anti-corrosive fluids.

Installation position / direction of flow

NOTICE!

The flowmeter can be mounted into the pipe system at any desired angle. However, the device is best vented when it is mounted upright. The medium must flow in the direction of the arrow.

Unimpeded flow sections

NOTICE!
Measuring inaccuracy due to incorrect installation!

The measuring accuracy of the flowmeter is influenced by its position within the pipe system. Changes in cross-section, branch-offs or bends in the pipe system impair measuring accuracy.

- Ensure that the unimpeded flow sections are maintained
- Never reduce the pipe diameter immediately before the device

- An unimpeded flow section of 10 x DN (rated width) must be maintained before the device.
- An unimpeded flow section of 5 x DN (rated width) must be maintained after the device.

Unimpeded outlet

NOTICE!

If the pipe system ends at an unimpeded outlet, the flowmeter must not be installed directly in front of the opening. The device must always be completely filled with media to ensure measuring accuracy.

Prepare the device

NOTICE!



Risk of damage to property due to contamination!

Contamination and deposits may impair the free movement of the impeller, thereby damaging the device.

- Ensure that there are no foreign particles in the device
- Ensure that the device is not soiled



Due to quality assurance measures, there may be some test medium (water) residue in the device.

1.  Unpack the device, remove the sealing caps at the inlet and outlet ends and visually inspect the device to ensure that it is free of packaging materials
2.  Examine the device for residue of test medium and drain, if necessary
3.  Check device for soiling and flush with clean medium, if necessary

5.4 Installation in the pipe system

WARNING!

Risk of injury from pressurized lines!

If the pipe system is under pressure when installing the device, severe injury may result.

- Depressurize the pipe system before installing the device

 **WARNING!**

Risk of injury from hot or cold surfaces!

Pipelines can heat up or cool down dramatically due to the media flowing through them. Skin contact with hot or cold surfaces may cause severe skin burn or frostbite.

- Before commencing work, ensure that the system has been controlled to a temperature range between 0 and 40 °C
- Do not touch any parts of the system that are either very cold or very hot
- Always wear heat-resistant or cold-resistant protective work clothing and protective gloves when working near hot or cold surfaces

 **WARNING!**

Risk of injury from media in the pipe system!

If the pipe system contains toxic or other hazardous media, severe injuries may be caused by escaping media.

- Before installation, ensure that the pipe system is empty and does not contain any media residue
- Always wear personal protective equipment during installation
- Provide suitable draining devices (drip pans, collection tank, etc.)

 **NOTICE!**

Risk of damage to device due to contaminated pipe system!

Dirt and foreign particles entering the device can damage the device and impair its operation.

- Ensure that the pipe system is clean before installing the device
- If necessary, flush the pipe system with clean medium before installation



A matching process connection must be available within the pipe system to connect the device.



A suitable sealant must be selected, depending on the condition or composition of the pipelines, the medium, as well as the operating and environmental conditions.

Installing the device in the pipe system with connector adapters (recommended)

Personnel:

- Qualified personnel

Protective equipment:

- As specified in the Safety Data Sheet of the medium, **protective equipment** must be worn when handling hazardous media. In addition, the specifications of the system operator must be followed. If no protective equipment is specified, suitable protective gloves and goggles must be worn.
- Protective gloves
- Goggles

Tools:

- Fixed spanner
- Pipe wrench

The turbine is fitted in the housing and is held in the correct position by the connector adapters. Moreover, these additional fittings allow easy installation and removal of the device.





Suitable connector adapters are available as accessories!

1.  Seal the pipe system correctly. Use only suitable sealants!

! NOTICE!

Utmost care must be taken to ensure that no fibrous sealants such as hemp or Teflon® get into the flow as these can damage the device! Keep in mind that liquid sealants can damage the turbine insert or make it unusable!

2.  Now install the connector adapters in the pipe system.
3.  Now install the device within the pipe system by using the above mentioned tools. Note the direction of flow (see arrow on device)
4.  Ensure the proper seat of the included seals and securely fasten the union nuts.

Installing the device in the pipe system without connector adapters

Personnel:

- Qualified personnel

Protective equipment:

- As specified in the Safety Data Sheet of the medium, **protective equipment** must be worn when handling hazardous media. In addition, the specifications of the system operator must be followed. If no protective equipment is specified, suitable protective gloves and goggles must be worn.
- Protective gloves
- Goggles

Tools:

- Fixed spanner
- Pipe wrench



The flowmeter can be installed in the pipe system without connector adapters if the following instructions are observed:

- *The pipe system must have a collar at the outlet side of the flowmeter which prevents slipping of the turbine insert.*
- *Recommended dimensions are:*
 - *Internal diameter: 25-26 mm*
 - *External diameter: 38-38,5 mm*
- *Ensure the proper seat of the included seals during installation.*

5.5 Initial startup

The following steps must be taken before initial startup and any subsequent startup (e.g. after removal and installation during maintenance).

1. 



WARNING!

Ensure that the plant is operating vibration-free. Vibrations could destroy the device. This may result in serious injury to the user.

2. 



WARNING!

Ensure that the medium is flowing continuously. Pulse-like staggered loads could destroy the device. This may result in serious injury to the user.

3. 



NOTICE!

Completely fill the pipelines. Partial filling(s) may result in malfunctions and damage to the device.

4. 

! NOTICE!

Vent the pipeline. If there are air pockets in the line during the measurement, this could result in damage to the device caused by hydraulic shock. This may cause malfunctions.

5. 

! NOTICE!

Ensure that the plant is operating without cavitation. Cavitation may result in malfunctions and damage to the device.

 DANGER!

Danger to life from electrical current

There is an immediate risk to life from electrocution on touching live parts. Damage to the electrical insulation or single components can be extremely dangerous.

- Only qualified electricians shall work on the electrical system
- If the insulation is damaged, immediately switch off and have repairs performed.
- Before commencing work on live parts of electrical systems and components, disconnect the equipment and ensure that it remains disconnected for the duration of the work. Observe these 5 safety rules when doing so:
 - Isolate (disconnect)
 - Secure against switching back on
 - Check for absence of voltage
 - Ground and short
 - Cover or cordon off other live parts in the vicinity

5.6 Electrical connection

The electrical connection of the flowmeter is accomplished through the shielded connection cable. Connect the shielding at the lead ends to ground.

Personnel:

- Qualified electrician

- Never bridge fuses or put them out of operation. Always observe the correct current ratings when replacing fuses
- Keep moisture away from live parts. This may result in short-circuit

! NOTICE!

The sleeve of the sensor (Hall-Sensor) is sealed and must not be loosened or opened!

5.6.1 Connection diagram

Connection diagram

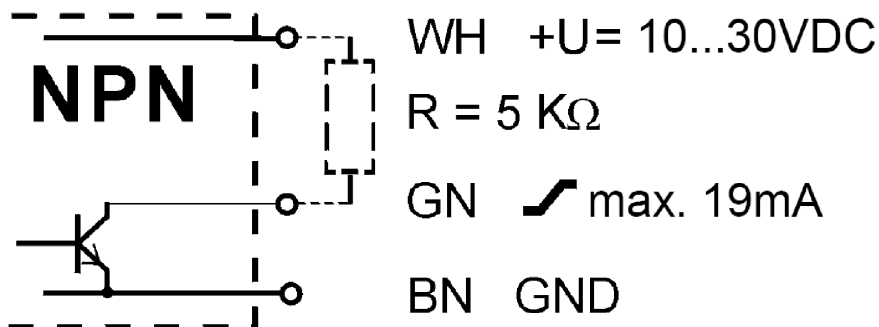

Fig. 3: Connection diagram

BN brown
 GN green
 WH white
 R Resistor



An optional power supply of 4,5 - 26,5 V DC is available.

A pull-up resistor of 5 kΩ is recommended.

6 Operation

6.1 Adjusting the measuring range

Adjustments to the measuring range or flow limits (upper or lower) are not possible. The measuring electronics generate evaluable square wave signals when the flow rate is above 1 l/min.



It is necessary to install suitable evaluation electronics to analyze the square wave signals generated by the measuring electronics in the flowmeter.

6.2 Pulse characteristics

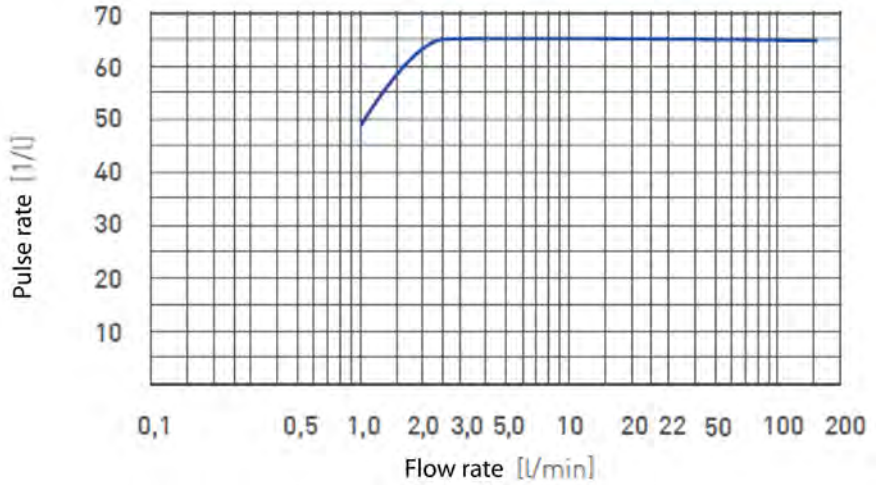

Fig. 4: Pulse characteristics

7 Troubleshooting

This chapter describes possible malfunctions of the device, their causes and repair.

If malfunctions persist or increase, shorten the maintenance interval to meet the actual operating conditions.

For malfunctions not described in this chapter, please contact the manufacturer (see service address on page 2).

7.1 Safety

Work performed incorrectly to remedy a malfunction



WARNING!

Risk of injury due to incorrect repair of malfunction!





Work performed incorrectly may result in severe injury and considerable damage to property

- Ensure that the site is sufficiently cleared before commencing work
- Ensure that the repair location is orderly and clean! Components and tools that are lying about or on top of each other are potential causes of accidents
- Before placing the device back into operation, ensure that all work has been performed and completed in compliance with the specifications and instructions in these Operating Instructions

Conduct in case of malfunction

The complete machine or system may be unsafe if there is a defect at the flowmeter (e.g. a burst housing).



The following always applies:

1.  In case of malfunctions that present an immediate danger to persons or valuables, proceed according to the valid emergency plans for the system
2.  Determine the cause of the malfunction
3.  Before repair, ensure that there is no danger to persons from escaping media
4.  If necessary, allow the pipeline and device to cool down or to warm up before commencing work
5.  Malfunctions must be corrected by qualified personnel



The following troubleshooting guide provides an indication of who is qualified to repair the fault.

7.2 Troubleshooting guide

Fault description	Cause	Remedy	Personnel
No evaluable pulses are detected	Missing or faulty electrical connection	Connect the device correctly according to  <i>Chapter 5.6.1 "Connection diagram" on page 35</i>	Qualified electrician
No evaluable pulses are detected despite proper electrical connection of the device	Turbine is blocked	Remove the device from the pipe system. Check the unimpeded rotation of the turbine and if necessary clean the device thoroughly. Should these measures fail to remedy the malfunction return the device to the manufacturer according to  <i>Chapter 9.5 "Return Materials" on page 48</i>	Qualified personnel

8 Maintenance

8.1 Maintenance table

Maintenance interval and replacement of defective parts

! NOTICE!

- Disassembling the device is prohibited! Disassembling the device will void the warranty!
- Disassembly and replacement of defective parts may only be performed by the manufacturer! Only maintenance work is allowed, which does not require disassembly.
- The knurled union nut is sealed! It is strictly prohibited to loosen or remove this nut! Doing so will cause the mounting of the turbine insert to be released! Subsequently, the turbine insert will be out of alignment and a complete overhaul by the manufacturer will be required!



The device must be returned to the manufacturer for maintenance requiring disassembly. For further information see  Chapter 9.5 "Return Materials" on page 48

The following maintenance work can be performed without disassembling the device:

Interval	Maintenance work	Personnel
As required	Check for unrestricted rotation of the turbine	Qualified personnel
	Check the device for any signs of leakage	Qualified personnel
	Clean the device The device is cleaned by flushing in the <u>opposite</u> direction of the flow. See  <i>Chapter 8.1.1 "Cleaning" on page 42</i>	Qualified personnel

8.1.1 Cleaning

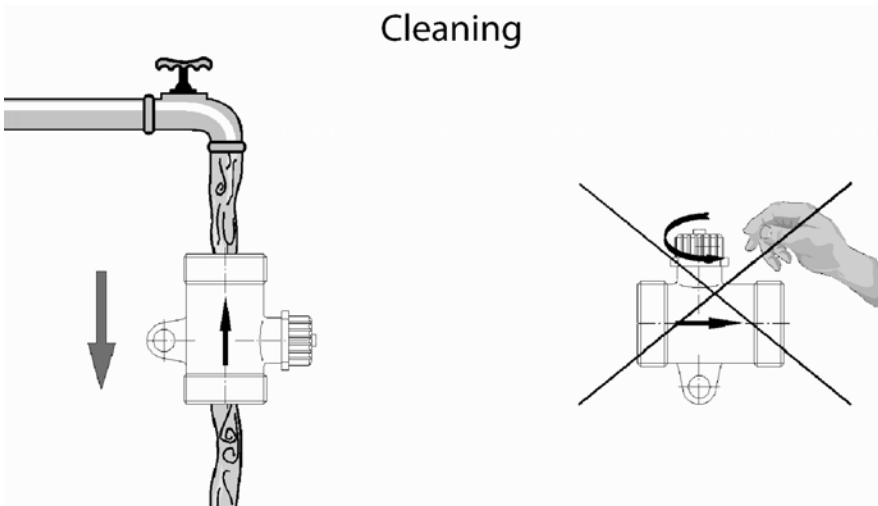

Fig. 5: Flushing and cleaning the device

! NOTICE!

Do not use compressed air to clean the device as it may damage the turbine bearings!

9 Disassembly and disposal

After its period of useful life, the device must be disassembled and disposed of in an environmentally safe manner.

9.1 Safety



WARNING!

Risk of injury if disassembled incorrectly!

Media residue, sharp edged components, pointed ends and corners on and in the device or on tools may cause injury.

- Ensure that the site is sufficiently cleared before commencing work
- Always wear protective equipment when handling hazardous media residue
- Handle open, or sharp-edged components carefully
- Ensure that the workplace is orderly and clean! Components and tools that are lying about or on top of each other are potential causes for accidents
- Disassemble components professionally
- Secure components so that they do not fall or overturn
- If in doubt, contact the manufacturer

9.2 Removal from the pipe system

The device must be removed from the pipe system before disassembly and disposal.



WARNING!

Risk of injury from pressurized lines!

Severe injury may result if the pipe system is under pressure when removing the device.

- Depressurize the system before removing the device



WARNING!

Risk of injury from hot or cold surfaces!

Pipelines can heat up or cool down dramatically due to the media flowing through them. Skin contact with hot or cold surfaces causes severe skin burn or frostbite.

- Before removing the device, ensure that the machine or system and the flow monitor have been controlled to a temperature range between 0 °C and 40°C / 32 °F and 104°F
- Do not touch any part of the machine or system that is either very hot or very cold
- Always wear heat-resistant or cold-resistant protective work clothing and protective gloves when working near hot or cold surfaces



WARNING!

Risk of injury from media in the pipe system!

If the pipe system contains hazardous media, severe injury may be caused by escaping media.

- Before removing the device, ensure that the pipe system is empty and does not contain media residue
- Always wear personal protective equipment when removing the device

**WARNING!****Risk of injury from media residue in the device!**

After the pipe system has been emptied, media residue may still be present inside the device. In the case of hazardous media, this could result in serious injury.

- When removing (de-installing the device from the pipe system), always wear personal protective equipment
- All requirements specified in the media safety data sheet must be observed in accomplishing the work task
- Residue of hazardous media in the device can result in serious injury

Removal from the pipe system**WARNING!**

When removing the device from the system, do not exert excessive force as it may damage the device housing.

Personnel:



- Qualified personnel

Protective equipment:

- As specified in the Safety Data Sheet of the medium, **protective equipment** must be worn when handling hazardous media. In addition, the specifications of the system operator must be followed. If no protective equipment is specified, suitable protective gloves and goggles must be worn.
- Goggles
- Protective gloves

Tools:

- Fixed spanner
- Pipe wrench (preferably with 90° jaw position)

1.  Remove the device from the pipe system by loosening the adapter union that is holding the device. To aid removal, grip the device carefully with the pipe wrench
2.  Ensure the device is secured against falling and repeat step 1 on the opposite adapter union

9.3 Disassembly

Before disassembly:

- Dispose of any operating materials and auxiliary materials in an environmentally safe manner

! NOTICE!

Disassembling the device is not allowed other than for disposal purposes.

Personnel:

- Qualified personnel

Protective equipment:

- As specified in the Safety Data Sheet of the medium, **protective equipment** must be worn when handling hazardous media. In addition, the specifications of the system operator must be followed. If no protective equipment is specified, suitable protective gloves and goggles must be worn.
 - Goggles
 - Protective gloves
1. ➤ Remove the device from the pipe system
 2. ➤ Clean components and remove media residue
 3. ➤ Dispose in an environmentally safe manner

9.4 Disposal

If no return or disposal agreement has been made, recycle disassembled components:

- Scrap metals
- Recycle plastic elements
- Dispose of the remaining components according to their material properties

! NOTICE!

Danger to the environment due to incorrect disposal!

Potential risk to the environment may arise due to incorrect disposal.

- Have electrical scrap, electronic components, lubricants and other supplies disposed of by approved specialists
- In case of doubt, obtain information on environmentally safe disposal from the local authority or special disposal expert

9.5 Return Materials

9.5.1 Return Materials Authorization

For products being returned, regardless of the reason, the currently valid provisions of the returns policy set by MEISTER will apply. Return shipments which do not comply with the returns policy may be refused by MEISTER at the expense of the consignor.

10 Technical data

10.1 Device data plate

The data plate is on the mechanical part of the flow monitor/flowmeter and contains the following information:



Fig. 6: Device data plate

10.2 Dimension sheet

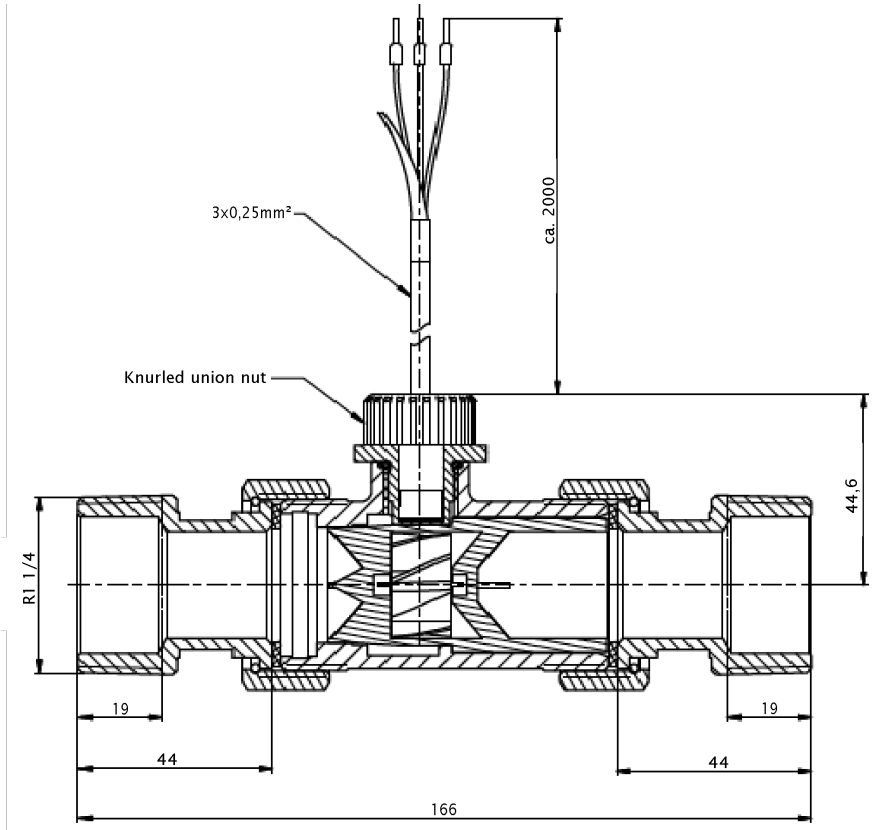

Fig. 7: Dimension sheet

10.3 General specifications

Table 2: Operating data

Nominal diameter	DN 25
Nominal pressure	PN 10

Pressure drop	see diagram (↪ <i>Chapter 10.3.1 "Installation data" on page 52</i>)
Media temperature, max.	85 °C / 185 °F
Ambient temperature	0 - 75 °C / 32 - 167 °F
Measuring accuracy	±5 % of measured value
Repeatability	±0,5 % of measured value
Signal activation	above 1 l/min / see diagram ↪ <i>Chapter 6.2 "Pulse characteristics" on page 37</i>
Max. size of particles in the medium	smaller than 0,63 mm



For flow rates up to 5 l/min the measuring accuracy is ±7 % of the measured value.

Table 3: Electrical data

Sensor	Hall-Sensor
Power supply	10 - 30 V DC
Signal activation	above 1 l/min
Pulse rate / K-Factor	65 Pulses/l
Resolution	15 ml/Pulse
Signal form	Square wave signal / NPN / open collector
Signal current max.	19 mA
Pull-up resistor	5 kΩ
Connection diagram	see diagram ↪ <i>Chapter 10.3.1 "Installation data" on page 52</i>

Electrical connection	Cable (2 m), PVC, shielded
Ingress protection	IP54



An optional power supply of 4,5 - 26,5 V DC is available.

A pull-up resistor of 5 kΩ is recommended.

Table 4: Measuring ranges (for H₂O at 20 °C / 68 °F)

Type	l/min
TDHK-25I/MS	4 - 160



Measurement of liquids with higher viscosities is possible with a deviation from the mentioned values.

For continuous operation the flow rate is limited to max. 80 l/min.

10.3.1 Installation data

Type	Sensor	Thread	DN	PN
TDHK-25I/MS	Hall-Sensor	G 1 1/4"	25	10



The device features an external thread. Additional connector adapters are recommended. These are available as accessories.

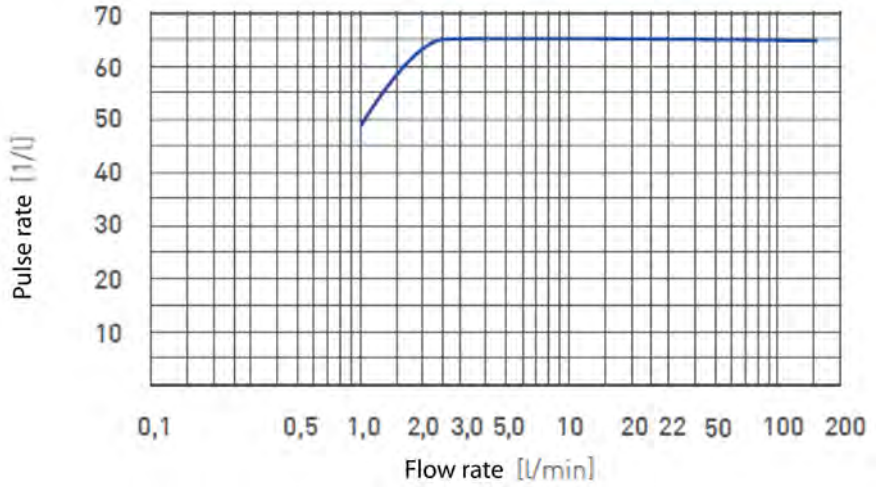

Fig. 8: Pulse characteristics

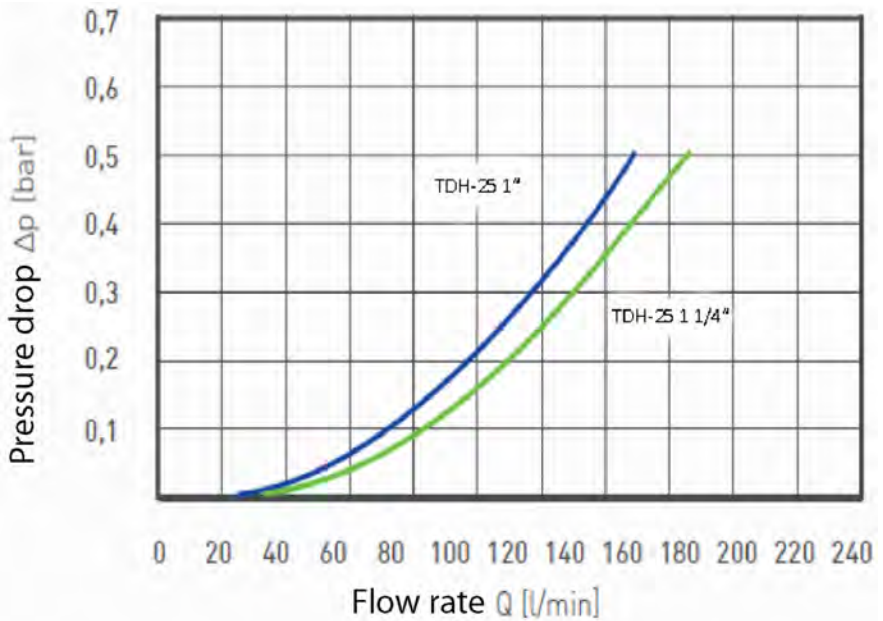

Fig. 9: Pressure drop

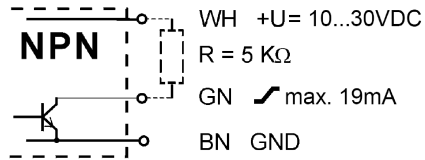

Fig. 10: Connection diagram

- BN brown
- GN green
- WH white
- R Resistor

11 Annex

11.1 Sealant



Before using a sealant, ensure that it is compatible with the media used and that it can be employed under the given operating conditions.

- Ensure proper seal
- Use a suitable sealant. Liquid sealants will damage the flowmeter when they flow into it.
- Always follow the sealant manufacturer's instructions

12 Index

A

Air pockets	
Cavitation	26
Anti-corrosive fluids	
Anti-freeze fluids	27
Application	10

C

Connection diagram	35
Contact	8
Copyright	3
Correct use in accordance with these instructions	10
Customer service	8

D

Device data plate	49
Device description	21
Dimension sheet	50
Disassembly	46
Disposal	47

E

Electrical connection	33
Electrical data	51
Environmental protection	17
cleaning fluids	17

G

General	
safety	9

H

Handling of measurement units	10
Hazard	
electrical current	12
Hazards	
mechanical	13
media	15
radiation	14
temperature	14

I

Initial startup	32
Installation	
pipe system	28
preparations	27
process connection	30
sealing	30
with connector adapters	30
without connector adapters	31

L

Limitation of liability	3
-----------------------------------	---

M

Maintenance	42
-----------------------	----

O

Operating data	50
Overview	20
Owner	18

P			
Packaging	22	Sealant	55
Precautions		Service	8
general	12	Storage	23
Preparation		Symbols	
device	28	packaging	23
R		Symbols used	
Removal from the pipe system . . .	44	in the instructions	9
Return Materials Authorization . . .	48	T	
S		Transport inspection	22
Safety		Troubleshooting guide	40
disassembly	44	U	
Safety equipment	16, 17	Unimpeded flow sections	27
Safety instructions		W	
transport	22	Warranty and guarantee provisions	8